

Features

- 3.2mm*1.5mm SMT LED, Super thin (1.0H mm)
- Low Power Consumption
- Wide Viewing Angle
- Various Colors
- Compatible with automatic placement equipment.
- Compatible with infrared and vapor phase reflow and wave solder process.
- Meet ROHS Green Product

Applications

- Backlight and Indicator

Package Dimensions

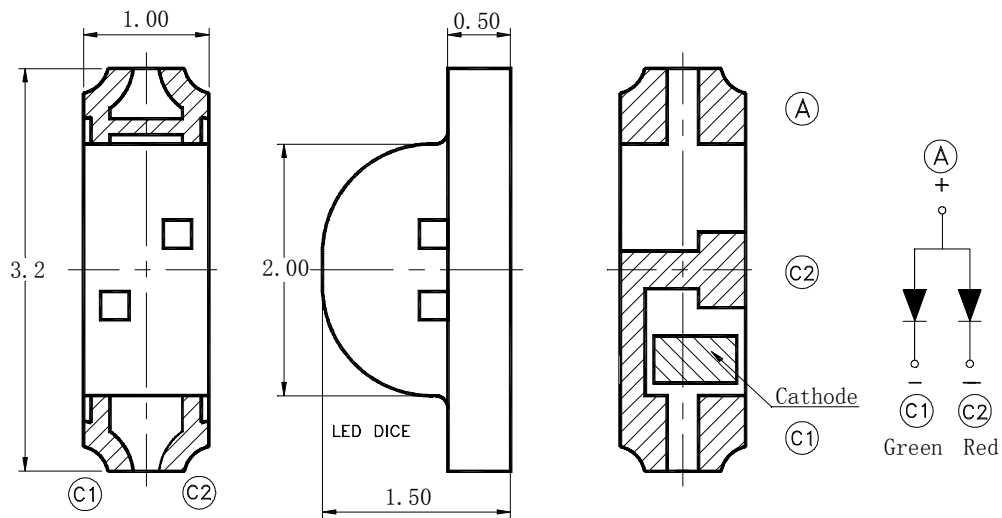

Notes:

1. All dimensions are in millimeters (inches).
2. Tolerance is $\pm 0.2\text{mm}$ (.0079") unless otherwise noted.
3. Specifications are subject to change without notice
4. This drawing is only for reference, not as a basis for the actual structure.



Selection Guide

Part No	Lens Type	Dice	Emitted Color
FSL-3215100HGR-SCHQ	Water Clear	AllnGaP	Green Red

Electrical / Optical Characteristics At Ta=25°C

Symbol	Parameter				Unit	Test Condition
			Green	Red		
Iv	Luminous Intensity	MIN.	45	45	mcd	IF=20mA
		TYP.	72	90		
		MAX.	280	280		
2θ1/2	Viewing Angle	TYP.	130	130	deg	IF=20mA
λ Peak	Peak Emission Wavelength	TYP.	574	636	nm	IF=20mA
λ d	Dominant Wavelength	MIN.	567	615	nm	IF=20mA
		TYP.	573	622		
		MAX.	576	635		
Δλ	Spectral Line Half-Width	TYP.	15	20	nm	IF=20mA
VF	Forward Voltage	MIN.	1.6	1.7	V	IF=20mA
		TYP.	2.0	1.9		
		MAX.	2.6	2.4		
IR	Reverse Current	MAX.	100	100	uA	VR = 5V

Note:

1. θ1/2 is the angle from optical centerline where the luminous intensity is 1/2 optical centerline value

Absolute Maximum Ratings At Ta=25°C

Parameter	Red	Green	Unit
Power Dissipation	75	75	mW
Peak Forward Current[1]	80	80	mA
Continuous Forward Current	30	30	mA
Dreading Linear From 25°C	0.4	0.4	mA/°C
Reverse Voltage	5	5	V
Operating Temperature Range	-55°C to + 85°C		
Storage Temperature Range	-55°C to + 85°C		
Soldering Condition	260°C For 5 Seconds		

Electrical Optical Characteristics Curves At Ta=25°C

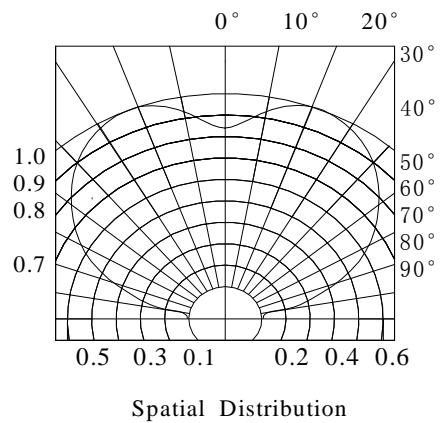
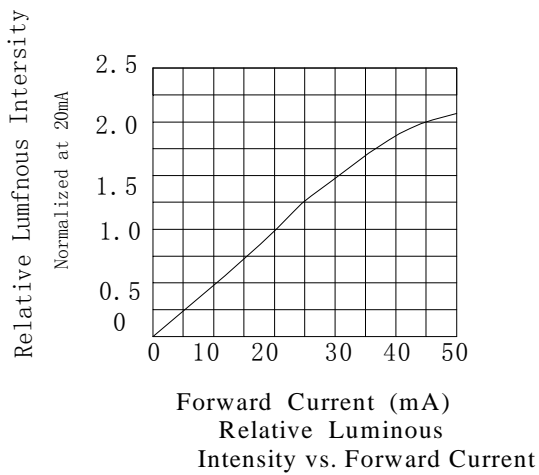
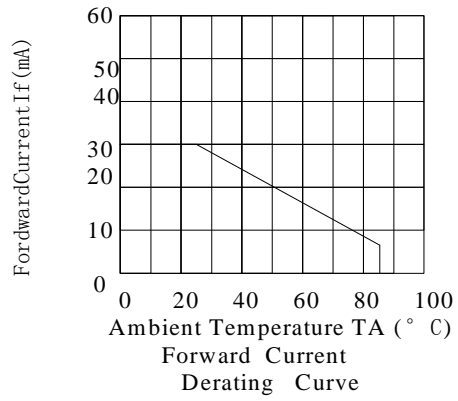
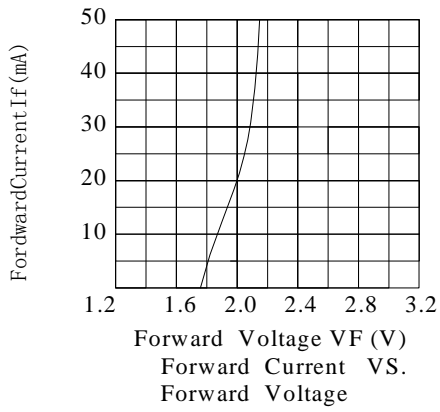
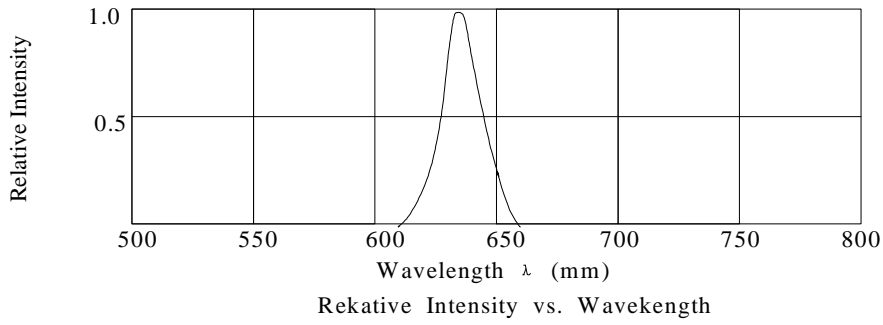

Electrical Optical Characteristics Curves At Ta=25°C

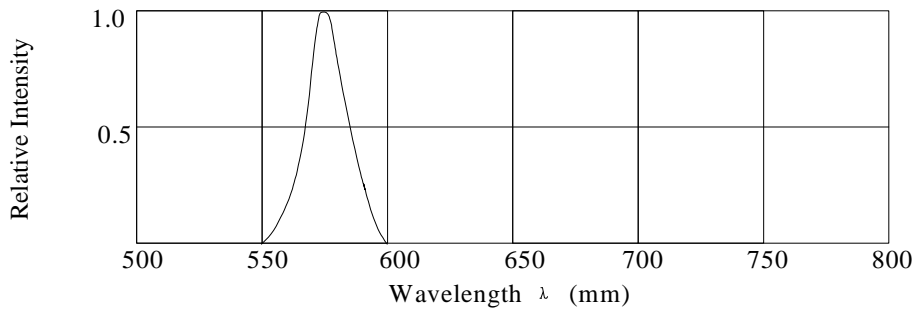

Fig.1 Relative Intensity vs. Wavelength

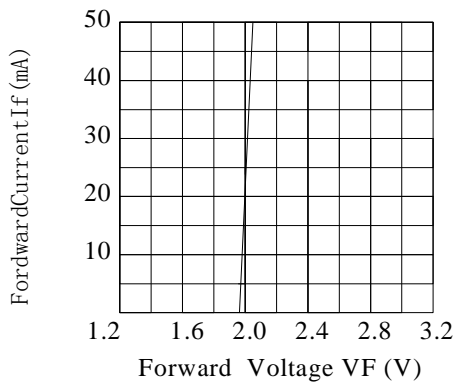

Fig.2 Forward Current VS. Forward Voltage

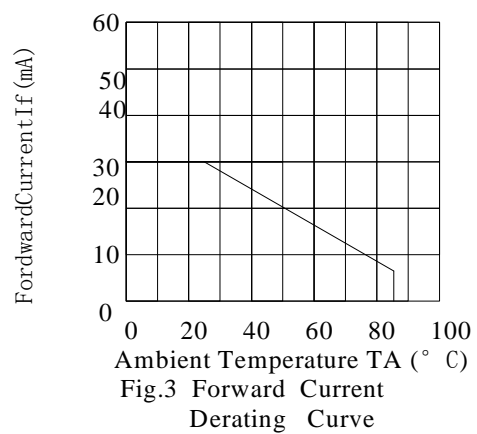

Fig.3 Forward Current Derating Curve

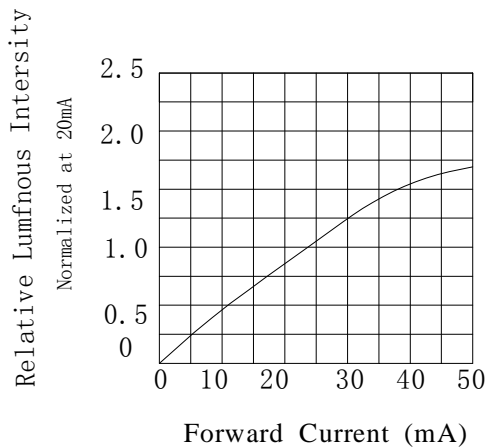

Fig.4 Relative Luminous Intensity vs. Forward Current

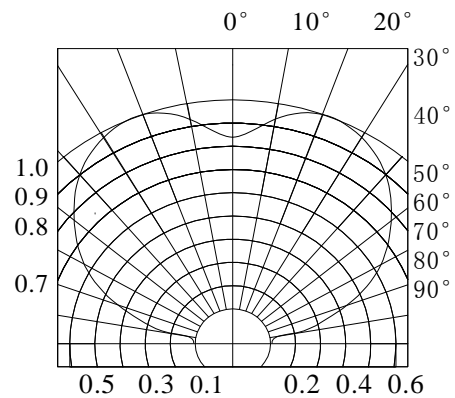

Fig.6 Spatial Distribution

Bin Range Of Luminous Intensity

Symbol	Bin Code	Min.	Max.	Unit	Condition
Iv(R)	P	45	72	mcd	IF=20mA
	Q	72	112		
	R	112	180		
	S	180	280		
Iv(G)	P	45	72	mcd	IF=20mA
	Q	72	112		
	R	112	180		
	S	180	280		

Bin Range Of Forward Voltage

Symbol	Bin Code	Min.	Max.	Unit	Condition
VF(R)	-	1.7	2.4	V	IF=20mA
VF(G)	-	1.6	2.6	V	IF=20mA

Bin Range Of Dominate Wavelength

Symbol	Bin Code	Min.	Max.	Unit	Condition
λ d(R)	-	615	635	nm	IF=20mA
λ d(G)	C	567	570	nm	IF=20mA
	D	570	573		
	E	573	576		

Notes:

1. Tolerance of Luminous Intensity +/-15%,the Luminous Intensity is measured with the led excluded the black lens cover.
2. Tolerance of Forward Voltage +/-0.1V
3. Tolerance of the Dominate Wavelength +/- 1nm

SMT Reflow Soldering Instructions

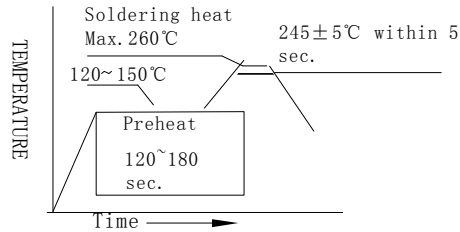

Notes:

1. Selles gives no other assurances regarding the ability of to withstand ESD. It is recommended to use a wrist band or anti-electrostatic glove when handling the LED. All devices, equipment and machinery must be properly grounded.
2. Reflow soldering should not be done more than two times.
3. Do not stress LED when soldering, and do not warp the circuit board after soldering
4. While using Iron, Power dissipation of Iron should be smaller than 25W, and temperature should be controllable. The work should be finished within 2 sec under 320°C for once only.

Recommended Soldering Pad Dimensions

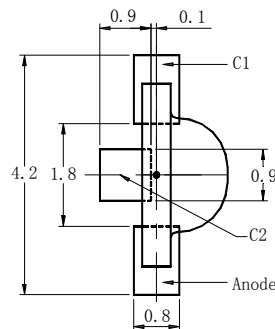

Package Specifications (Units: mm (inches))

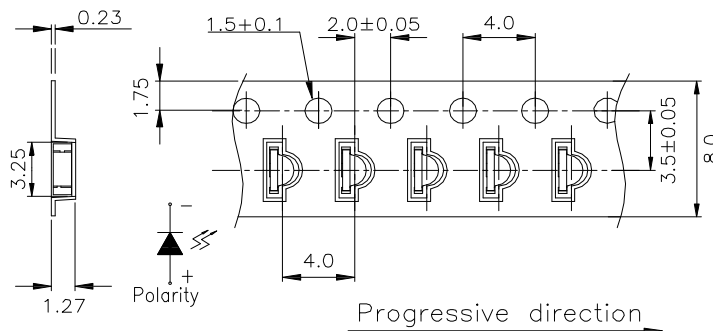

Notes:

1. The LEDs should be used within a year.
2. The LEDs should be kept in 5~30°C and 60% RH for less.
3. The LEDs should be used within 24 hours, or else should be kept in 5~30°C and 30% RH or less. And LEDs should be used within 7 days after opening the package.

Reliability Test Items Conditions

Classification	Test Item	Test Conditions	Test hours	Result
Endurance Test	Operation Life	Connect with a power $I_F=20\text{mA}$ T_a =Under room temperature	1000Hrs	0/20
	High Temperature High Humidity	$T_a=+65^\circ\text{C}\pm 5^\circ\text{C}$ RH=90%-95%	240Hrs	0/20
	High Temperature Storage	High $T_a=+85^\circ\text{C}\pm 5^\circ\text{C}$	1000Hrs	0/20
	Low Temperature Storage	Low $T_a=-35^\circ\text{C}\pm 5^\circ\text{C}$ Test time=1000hrs	1000Hrs	0/20
Environmental Test	Temperature Cycling	$-45^\circ\text{C}\sim+105^\circ\text{C}$ 15min 5min 15min	300 Cycles	0/20
	Thermal Shock	$-35^\circ\text{C}\sim\pm 5^\circ\text{C}\sim+85^\circ\text{C}\sim\pm 5^\circ\text{C}$ 5min 10sec 5min	300 Cycles	0/20
	Solder Resistance	Preheating: $120^\circ\text{C}-150^\circ\text{C}$, within 2 minutes. Operation heating : 260°C (Max.), within 5 seconds (Max.)	5Cycles	0/20

Judgment criteria of failure for the reliability

Measuring items	Symbol	Measuring conditions	Judgment criteria for failure
Forward voltage	$V_F(\text{V})$	$I_F=20\text{mA}$	Over $U\times 1.2$
Reverse current	$I_R(\mu\text{A})$	$V_R=5\text{V}$	Over $U\times 2$
Luminous intensity	$I_v(\text{mcd})$	$I_F=20\text{mA}$	Below $S\times 0.5$

Note: 1.U means the upper limit of specified characteristics. S means initial value.

2.Measurment shall be taken between 2 hours after the test pieces have been returned to normal ambient conditions after completion of each test.