

Features

- Low Power Consumption
- Wide Viewing Angle
- Various Colors
- Meet ROHS Green Product

Applications

- Backlight and Indicator

Package Dimensions

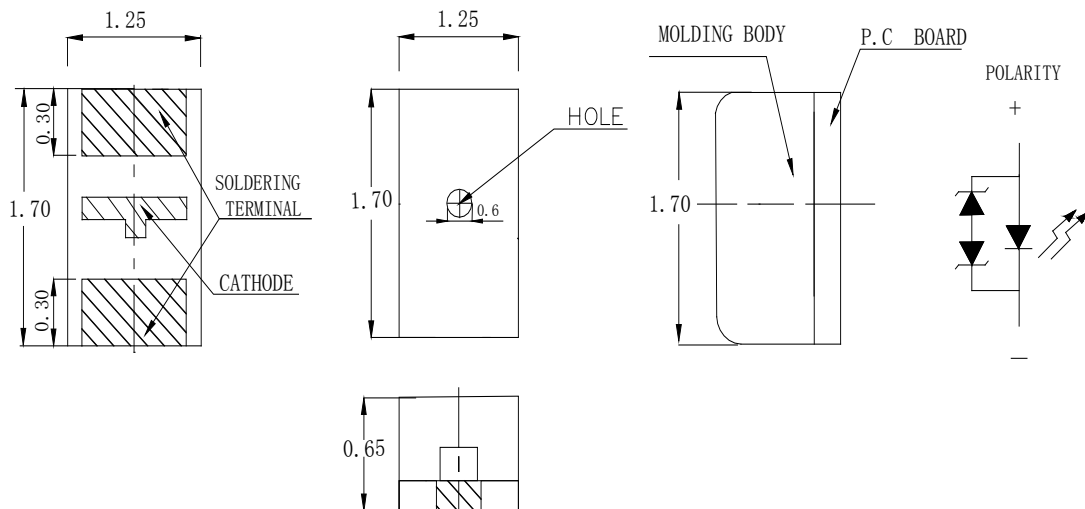

Patent Protection

Notes:

1. All dimensions are in millimeters (inches).
2. Tolerance is $\pm 0.2\text{mm}$ (.0079") unless otherwise noted.
3. Specifications are subject to change without notice
4. This drawing is only for reference, not as a basis for the actual structure.

www.FantasyLeds.com

Sales@FantasyLeds.com



Selection Guide

Part No	Lens Type	Dice	Emitted Color
FDC-T065W-6T5SCHLX	Black	InGaN	White

Electrical / Optical Characteristics At Ta=25 °C

Parameter	Symbol	Min.	Typ.	Max.	Unit	Test Condition
Iv	Luminous Intensity(Note 1)	28	90	180	mcd	IF=5mA
x	Chromaticity Coordinates		0.31			IF=5mA
y			0.31			
VF	Forward Voltage	2.55	2.9	3.3	V	IF=5mA
IR	Reverse Current			10	uA	VR=5V

Note:

1. The Luminous Intensity is measured with the led excluded the black lens cover.
2. The chromaticity coordinates(x,y) is derived form 1931 CIE chromaticity diagram.
3. The chromaticity coordinates(x,y) guarantee should be added±0.02 tolerance.

Absolute Maximum Ratings At Ta=25°C

Parameter	White	Unit
Power Dissipation	70	mW
Peak Forward Current	100	mA
Continuous Forward Current	20	mA
Dreading Linear From25°C	0.25	mA/°C
Reverse Voltage	5	V
Electrostatic Discharge Threshold(HBM)	2000	V
Operating Temperature Range	-20°C to + 80°C	
Storage Temperature Range	-55°C to + 85°C	
Soldering Condition	260°C For 5 Seconds	

Note:

1. 1/10DutyCycle,0.1msPulseWidth

Electrical Optical Characteristics Curves At Ta=25 °C

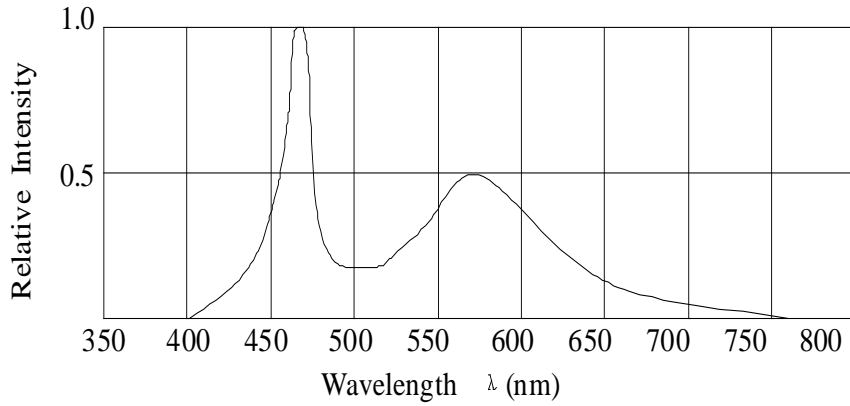

Fig.1 Relative Intensity VS. Wavelength

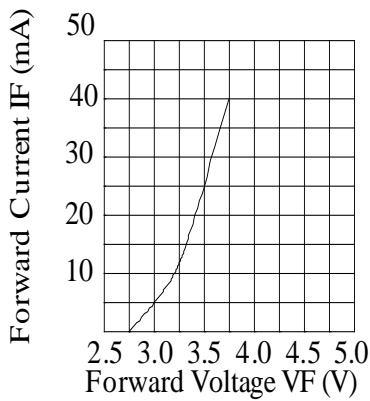

Fig.2 Forward Current vs. Forward Voltage

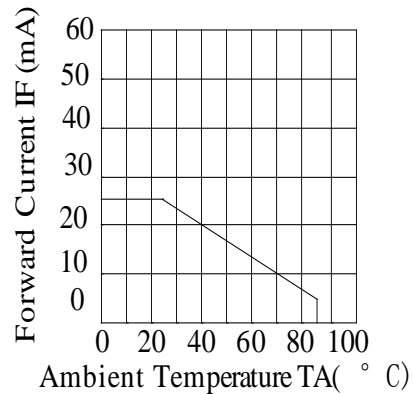

Fig.3 Forward Current Derating Curve

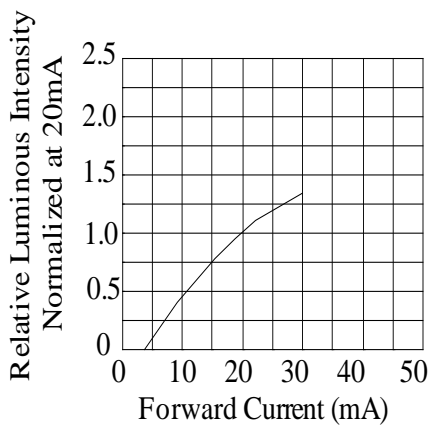

Fig.4 Relative Luminous Intensity vs. Forward Current

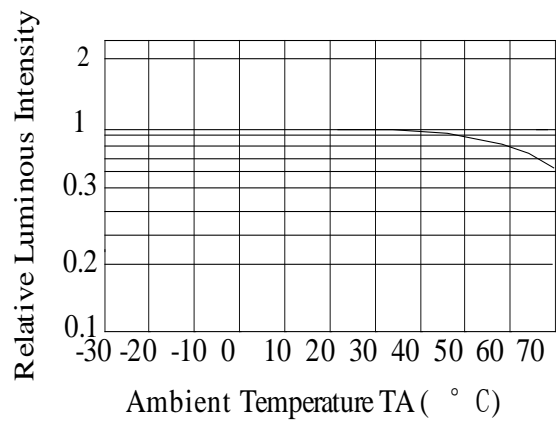

Fig.5 Luminous Intensity vs. Ambient Temperature

Bin Range Of Luminous Intensity (+/-20%)

Symbol	Bin Code	Min.	Max.	Unit	Condition
Iv	N	28	45	mcd	IF=5mA
	P	45	72		
	Q	72	112		
	R	112	180		

Bin Range Of Forward Voltage (+/-0.15)

Symbol	Bin Code	Min.	Max.	Unit	Condition
VF	V0	2.55	2.70	V	IF=5mA
	VA	2.70	2.85		
	VB	2.85	3.00		
	VC	3.00	3.15		
	VD	3.15	3.30		

Chromaticity Coordinates Specifications for Bin Grading (+/-0.02)

IF=5mA

BIN	X	Y	X	Y	X	Y	X	Y
B1	0.254	0.198	0.254	0.23	0.274	0.258	0.254	0.198
B2	0.254	0.23	0.254	0.263	0.274	0.291	0.274	0.258
B3	0.234	0.17	0.234	0.202	0.254	0.23	0.254	0.198
B4	0.234	0.202	0.234	0.235	0.254	0.263	0.254	0.23
S1	0.274	0.226	0.274	0.258	0.294	0.286	0.294	0.254
S2	0.274	0.258	0.274	0.291	0.294	0.319	0.294	0.286
S3	0.294	0.254	0.294	0.286	0.314	0.315	0.314	0.282
S4	0.294	0.286	0.294	0.319	0.314	0.347	0.314	0.315
S5	0.314	0.282	0.314	0.315	0.334	0.343	0.334	0.311
S6	0.314	0.315	0.314	0.347	0.334	0.376	0.334	0.343

CIE Chromaticity Diagram (+/-0.02)

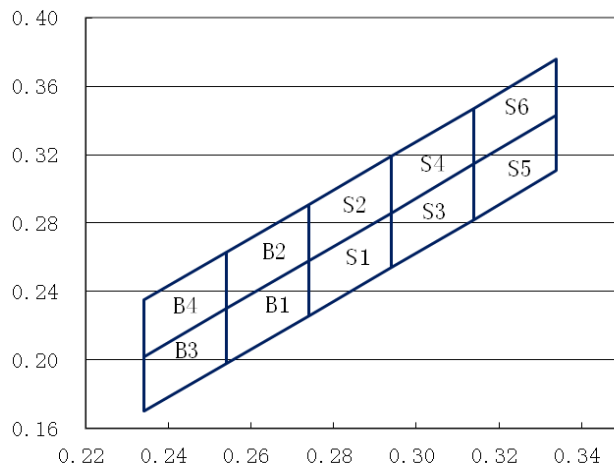

Process Note

1. Seller gives no other assurances regarding the ability of to withstand ESD. It is recommended to use a wrist band or anti-electrostatic glove when handling the LED. All devices, equipment and machinery must be properly grounded.
2. Reflow soldering should not be done more than two times.
3. Do not stress LED when soldering, and do not warp the circuit board after soldering
4. While using Iron, Power dissipation of Iron should be smaller than 25W, and temperature should be controllable. The work should be finished within 2 sec under 320°C for once only.

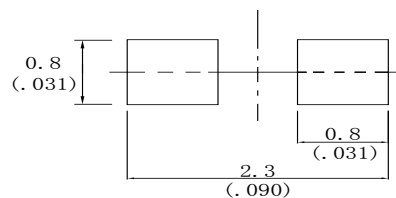
Recommended Soldering Pad Dimensions**Package Note :**

1. The LEDs should be used within a year.
2. The LEDs should be kept in 5~30°C and 60% RH for less.
3. The LEDs should be used within 24 hours, or else should be kept a 5~30°C and 30% RH or less. And LEDs should be used within 7 days after opening the package.

Reliability Test Items Conditions

Classification	Test Item	Test Conditions	Test hours	Result
Endurance Test	Operation Life	Connect with a power $I_F=5\text{mA}$ T_a =Under room temperature	1000Hrs	0/20
	High Temperature High Humidity	$T_a=+65^\circ\text{C}\pm 5^\circ\text{C}$ RH=90%-95%	240Hrs	0/20
	Hige Temperature Storage	High $T_a=+85^\circ\text{C}\pm 5^\circ\text{C}$	1000Hrs	0/20
	Low Temperature Storage	Low $T_a=-35^\circ\text{C}\pm 5^\circ\text{C}$ Test time=1000hrs	1000Hrs	0/20
Environmental Test	Temperature Cycling	$-45^\circ\text{C}\sim +105^\circ\text{C}$ 15min 5min 15min	300 Cycles	0/20
	Thermal Shock	$-35^\circ\text{C}\sim \pm 5^\circ\text{C}\sim +85^\circ\text{C}\sim \pm 5^\circ\text{C}$ 5min 10sec 5min	300 Cycles	0/20
	Solder Resistance	Preheating: $120^\circ\text{C}-150^\circ\text{C}$,within 2 minutes. Operation heating : 260°C (Max.),within5 seconds(Max.)	5Cycles	0/20

Judgment criteria of failure for the reliability

Measuring items	Symbol	Measuring conditions	Judgment criteria for failure
Forward voltage	$V_F(\text{V})$	$I_F=5\text{mA}$	Over $U\times 1.2$
Luminous intensity	$I_v(\text{mcd})$	$I_F=5\text{mA}$	Below $S\times 0.5$

Note: 1.U means the upper limit of specified characteristics. S means initial value.

2.Meansurment shall be taken between 2 hours after the test pieces have been returned to normal ambient conditions after completion of each test.