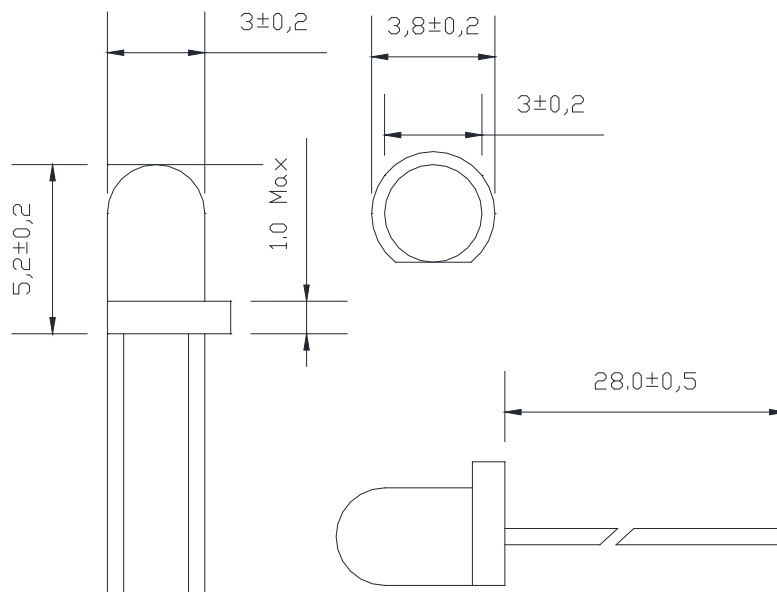

Features

- 3mm DIA LED Lamp
- Low Power Consumption
- High Efficiency
- Various Colors and Viewing Angle
- Long Solid State Reliability
- Package: 1000pcs/Packing

Applications

- Indicator

Package Dimensions**Notes:**

1. All dimensions are in millimeters (inches).
2. Tolerance is ± 0.25 mm(.01") unless otherwise noted.
3. Protruded Resin under flange is 1.0mm(0.04") max.
4. Specifications are subject to change without notice.



Selection Guide

Part No	Lens Type	Dice	Emitted Color
FDL-3521G-TGDYH-D28	Green Diffused	GaAsP	Green

Electrical / Optical Characteristics At Ta=25 °C

Symbol	Parameter	Min.	Typ.	Max.	Unit	Test Condition
Iv	Luminous Intensity		20		mcd	IF=20mA
2θ1/2	Viewing Angle		30		deg	IF=20mA
λ Peak	Peak Emission Wavelength		574		nm	IF=20mA
λ d	Dominant Wavelength		571		nm	IF=20mA
Δλ	Spectral Line Half-Width		20		nm	IF=20mA
VF	Forward Voltage		2.1	2.5	V	IF=20mA
IR	Reverse Current		10		uA	VR 5V

Note:

1. θ1/2 is the angle from optical centerline where the luminous intensity is 1/2 optical centerline value

Absolute Maximum Ratings At Ta=25°C

Parameter	Green	Unit
Power Dissipation	80	mW
Peak Forward Current[1]	150	mA
Continuous Forward Current	25	mA
Reverse Voltage	5	V
Operating Temperature Range	-40°C to + 85°C	
Storage Temperature Range	-40°C to + 85°C	
Soldering Condition	260°C For 5 Seconds	

Note:

1. 1/10DutyCycle, 0.1msPulseWidth

Electrical Optical Characteristics Curves At Ta=25 °C

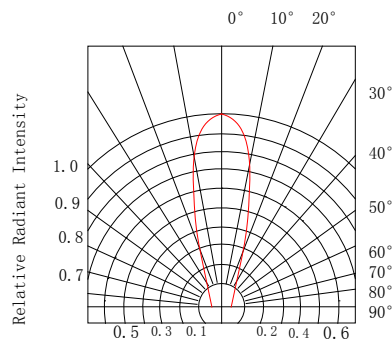
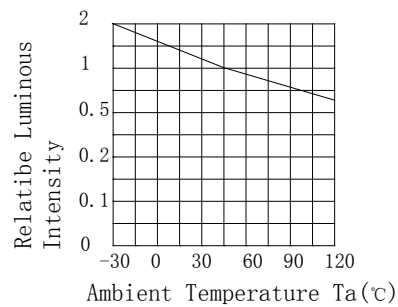
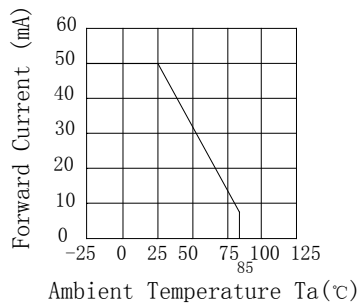
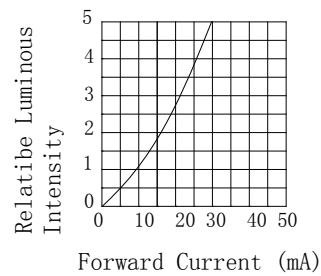
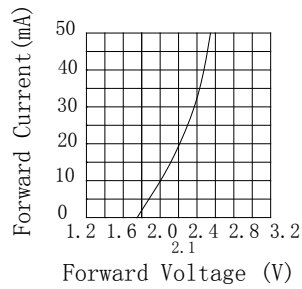
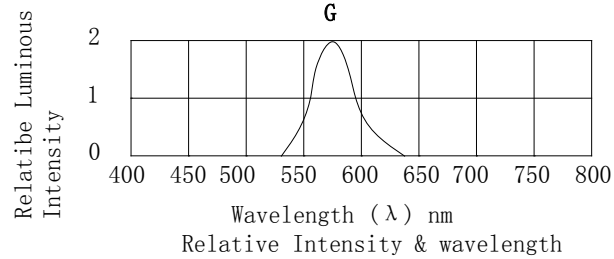

Fig. 6 Radiation Diagram

Notes:

1. The LEDs should be used within a year.
2. The LEDs should be kept in 5~30°C and 60% RH for less.
3. The LEDs should be used within 24 hours, or else should be kept a 5~30°C and 30% RH or less. And LEDs should be used within 7 days after opening the package.

Reliability Test Items Conditions

Classification	Test Item	Test Conditions	Test hours	Result
Endurance Test	Operation Life	Connect with a power $I_F=20mA$ T_a =Under room temperature	1000Hrs	0/20
	High Temperature High Humidity	$T_a=+65^{\circ}C\pm5^{\circ}C$ RH=90%-95%	240Hrs	0/20
	High Temperature Storage	High $T_a=+85^{\circ}C\pm5^{\circ}C$	1000Hrs	0/20
	Low Temperature Storage	Low $T_a=-35^{\circ}C\pm5^{\circ}C$ Test time=1000hrs	1000Hrs	0/20
Environmental Test	Temperature Cycling	$-45^{\circ}C \sim +105^{\circ}C$ 15min 5min 15min	300 Cycles	0/20
	Thermal Shock	$-35^{\circ}C \sim \pm5^{\circ}C \sim +85^{\circ}C \sim \pm5^{\circ}C$ 5min 10sec 5min	300 Cycles	0/20
	Solder Resistance	Preheating: $120^{\circ}C - 150^{\circ}C$, within 2 minutes. Operation heating : $260^{\circ}C$ (Max.), within 5 seconds (Max.)	5Cycles	0/20

Judgment criteria of failure for the reliability

Measuring items	Symbol	Measuring conditions	Judgment criteria for failure
Forward voltage	$V_F(V)$	$I_F=20mA$	Over $U \times 1.2$
Reverse current	$I_R(\mu A)$	$V_R=5V$	Over $U \times 2$
Luminous intensity	$I_v(mcd)$	$I_F=20mA$	Below $S \times 0.5$

Note: 1.U means the upper limit of specified characteristics. S means initial value.

2.Measurment shall be taken between 2 hours after the test pieces have been returned to normal ambient conditions after completion of each test.