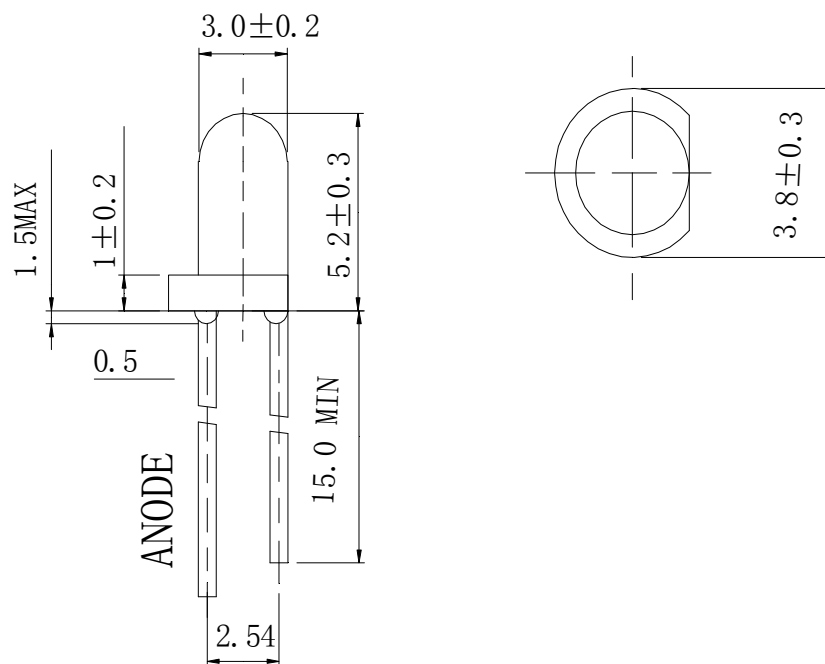

**Features**

- 3mm DIA LED Lamp
- Low Power Consumption
- High Efficiency
- Various Colors and Viewing Angle
- Long Solid State Reliability
- Package: 1000pcs/Packing

**Applications**

- Indicator

**Package Dimensions****Notes:**

1. All dimensions are in millimeters (inches).
2. Tolerance is  $\pm 0.25\text{mm}$  (.01") unless otherwise noted.
3. Protruded Resin under flange is 1.0mm(0.04") max.
4. Specifications are subject to change without notice.



**FDL-3521HW-ZWCS**

**Selection Guide**

Part No	Lens Type	Dice	Emitted Color
FDL-3521HW-ZWCS	Water Clear	InGaN	White

**Electrical / Optical Characteristics At Ta=25°C**

Parameter	Symbol	Min.	Typ.	Max.	Unit	Test Condition
Iv	Luminous Intensity	2250	3200		mcd	IF=20mA
2θ1/2	Viewing Angle		30		deg	
x	Chromaticity Coordinates		0.285		nm	IF=20mA
y			0.27			
VF	Forward Voltage	2.8	3.3	3.6	V	IF=20mA
IR	Reverse Current			50	μ A	VR 5V

Note:

1. θ1/2 is the angle from optical centerline where the luminous intensity is 1/2 optical centerline value
2. The chromaticity coordinates(x,y) is derived from 1931 CIE chromaticity diagram.
3. The chromaticity coordinates(x,y) guarantee should be added±0.02 tolerance.

**Absolute Maximum Ratings At Ta=25°C**

Parameter	White	Unit
Power Dissipation	70	mW
Peak Forward Current	100	mA
Continuous Forward Current	20	mA
Dreading Linear From25°C	0.25	mA/°C
Reverse Voltage	5	V
Electrostatic Discharge Threshold(HBM)	300	V
Operating Temperature Range	-20°C to + 80°C	
Storage Temperature Range	-55°C to + 85°C	
Soldering Condition	260°C For 5 Seconds	

Note:

1. 1/10DutyCycle,0.1msPulseWidth

**Electrical Optical Characteristics Curves At Ta=25°C**

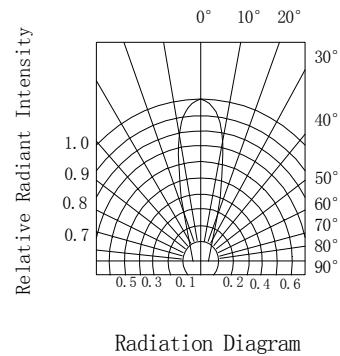
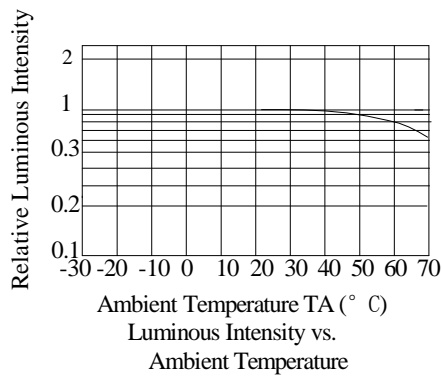
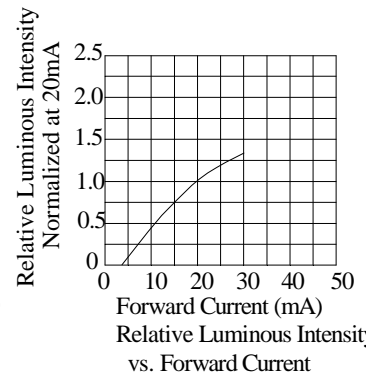
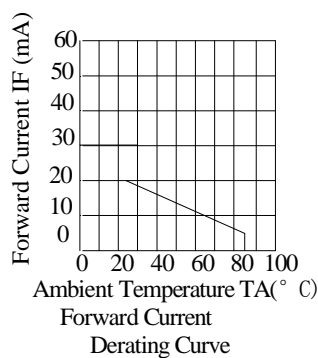
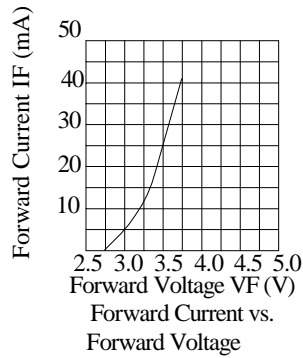
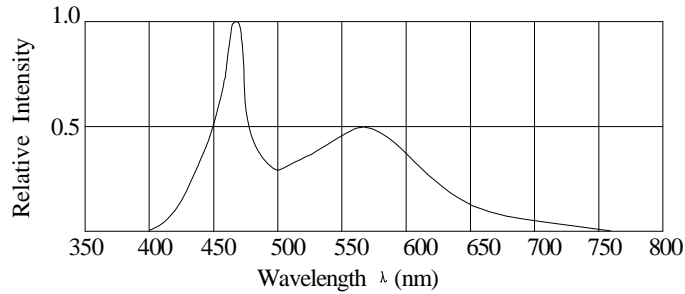

Notes:

1. The LEDs should be used within a year.
2. The LEDs should be kept in 5~30°C and 60% RH for less.
3. The LEDs should be used within 24 hours, or else should be kept a 5~30°C and 30% RH or less. And LEDs should be used within 7 days after opening the package.



**Chromaticity Coordinates Specifications for Bin Grading (+/-0.02) IF=20mA**

CA	0.254	0.23	CB	0.254	0.198	C1	0.274	0.226	C2	0.274	0.258
	0.254	0.263		0.254	0.23		0.274	0.258		0.274	0.291
	0.274	0.291		0.274	0.258		0.294	0.286		0.294	0.319
	0.274	0.258		0.274	0.226		0.294	0.254		0.294	0.286
	0.254	0.23		0.254	0.198		0.274	0.226		0.274	0.258
C3	0.294	0.254	C4	0.294	0.286	C5	0.314	0.282	C6	0.314	0.315
	0.294	0.286		0.294	0.319		0.314	0.315		0.314	0.347
	0.314	0.315		0.314	0.347		0.334	0.343		0.334	0.376
	0.314	0.282		0.314	0.315		0.334	0.311		0.334	0.343
	0.294	0.254		0.294	0.286		0.314	0.282		0.314	0.315

**CIE Chromaticity Diagram**

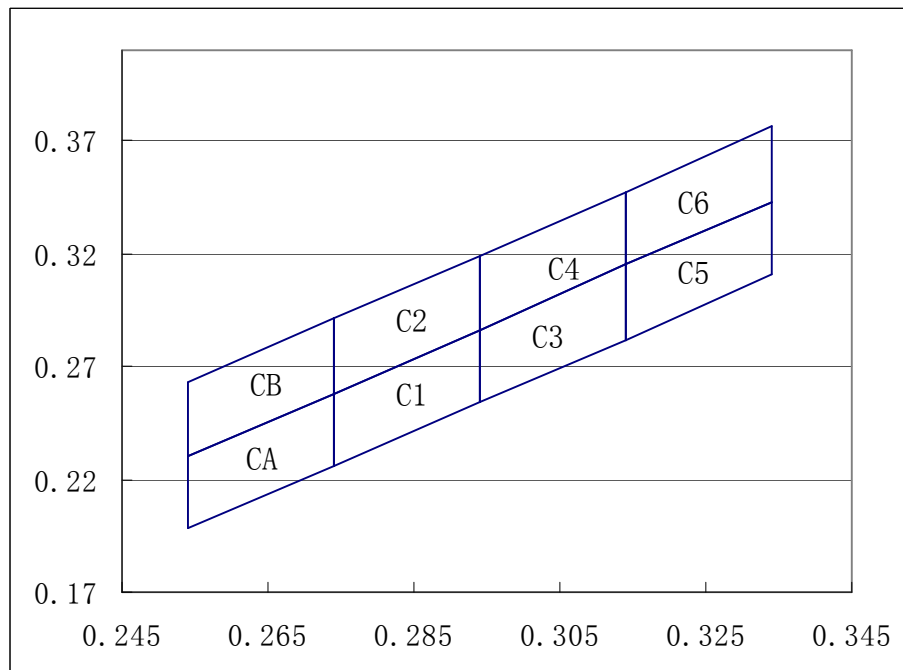



**Reliability Test Items Conditions**

Classification	Test Item	Test Conditions	Test hours	Result
Endurance Test	Operation Life	Connect with a power if=20mA Ta=Under room temperature	1000Hrs	0/20
	High Temperature High Humidity	Ta=+65°C±5°C RH=90%-95%	240Hrs	0/20
	High Temperature Storage	High Ta=+85°C±5°C	1000Hrs	0/20
	Low Temperature Storage	Low Ta=-35°C±5°C Test time=1000hrs	1000Hrs	0/20
Environmental Test	Temperature Cycling	-45°C ~ +105°C 15min 5min 15min	300 Cycles	0/20
	Thermal Shock	-35°C ~ ±5°C ~ +85°C ~ ±5°C 5min 10sec 5min	300 Cycles	0/20
	Solder Resistance	Preheating: 120°C -150°C ,within 2 minutes. Operation heating : 260°C (Max.),within 5 seconds(Max.)	5Cycles	0/20

**Judgment criteria of failure for the reliability**

Measuring items	Symbol	Measuring conditions	Judgment criteria for failure
Forward voltage	V <sub>F</sub> (V)	I <sub>F</sub> =20mA	Over U×1.2
Reverse current	I <sub>R</sub> (μA)	V <sub>R</sub> =5V	Over U×2
Luminous intensity	I <sub>v</sub> (mcd)	I <sub>F</sub> =20mA	Below S×0.5

Note: 1.U means the upper limit of specified characteristics. S means initial value.  
 2.Measurement shall be taken between 2 hours after the test pieces have been returned to normal ambient conditions after completion of each test.