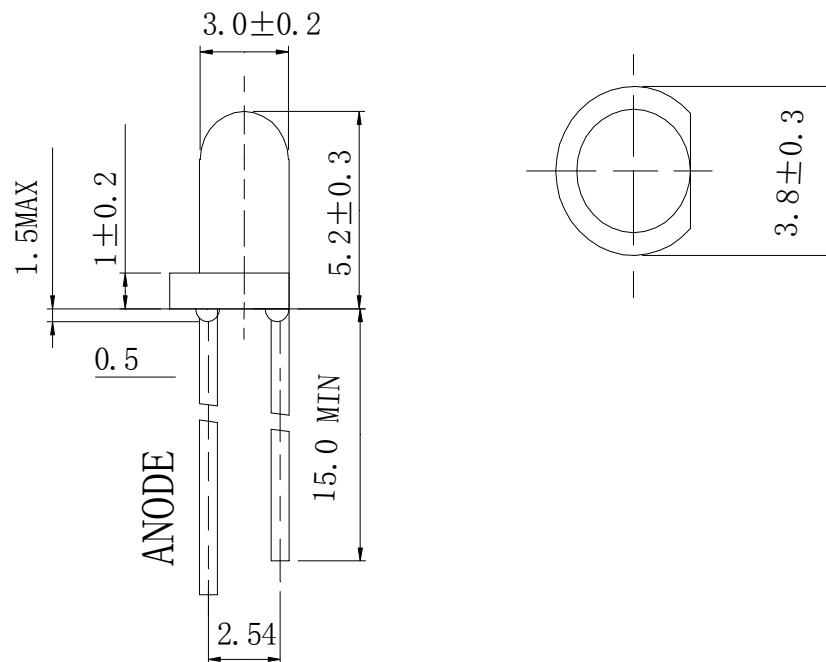

Features

- 3mm DIA LED Lamp
- Low Power Consumption
- High Efficiency
- Various Colors and Viewing Angle
- Long Solid State Reliability
- Package: 1000pcs/Packing

Applications

- Indicator

Package Dimensions**Notes:**

1. All dimensions are in millimeters (inches).
2. Tolerance is $\pm 0.25\text{mm}$ (.01") unless otherwise noted.
3. Protruded Resin under flange is 1.0mm(0.04") max.
4. Specifications are subject to change without notice.



FDL-3521Y-ZYDL-5

Selection Guide

Part No	Lens Type	Dice	Emitted Color
FDL-3521Y-ZYDL-5	Yellow Diffused	AlInGaP	Yellow

Electrical / Optical Characteristics At Ta=25°C

Symbol	Parameter	Min.	Typ.	Max.	Unit	Test Condition
Iv	Luminous Intensity	72	180		mcd	IF=20mA
2θ1/2	Viewing Angle		30		deg	IF=20mA
λ Peak	Peak Emission Wavelength		588		nm	IF=20mA
λ d	Dominant Wavelength		592		nm	IF=20mA
Δλ	Spectral Line Half-Width		15		nm	IF=20mA
VF	Forward Voltage		2.0	2.5	V	IF=20mA
IR	Reverse Current			5	uA	VR 5V

Note:

1. θ1/2 is the angle from optical centerline where the luminous intensity is 1/2 optical centerline value

Absolute Maximum Ratings At Ta=25°C

Parameter	Yellow	Unit
Power Dissipation	75	mW
Peak Forward Current[1]	80	mA
Continuous Forward Current	30	mA
Dreading Linear From 25°C	0.4	mA/°C
Reverse Voltage	5	V
Operating Temperature Range	-55°C to + 85°C	
Storage Temperature Range	-55°C to + 85°C	
Soldering Condition	260°C For 5 Seconds	

Note:

1. 1/10 Duty Cycle, 0.1ms Pulse Width

Electrical Optical Characteristics Curves At Ta=25°C

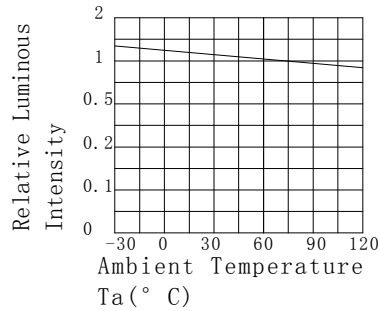
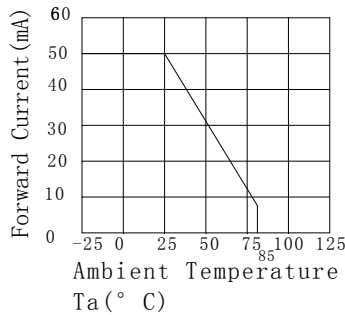
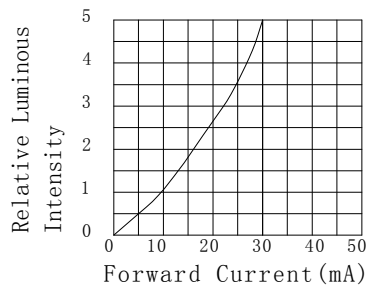
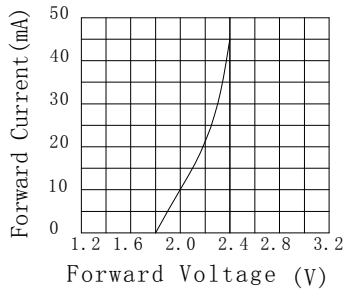
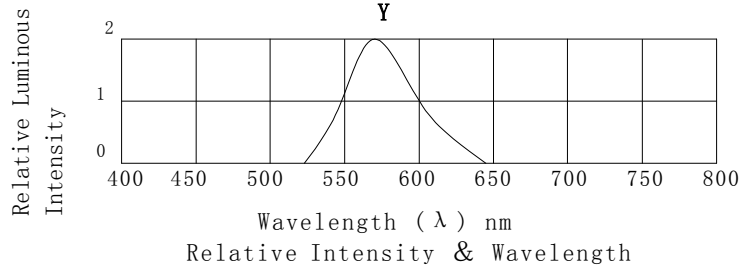

Reflow Soldering Instructions

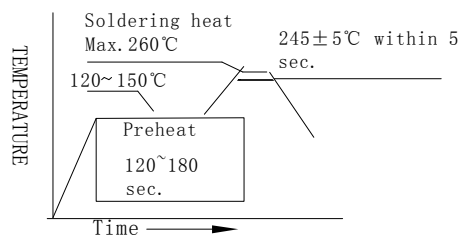

Notes:

1. The LEDs should be used within a year.
2. The LEDs should be kept in 5~30°C and 60% RH for less.
3. The LEDs should be used within 24 hours, or else should be kept a 5~30°C and 30% RH or less. And LEDs should be used within 7 days after opening the package.

Reliability Test Items Conditions

Classification	Test Item	Test Conditions	Test hours	Result
Endurance Test	Operation Life	Connect with a power $I_F=20\text{mA}$ T_a =Under room temperature	1000Hrs	0/20
	High Temperature High Humidity	$T_a=+65^\circ\text{C}\pm 5^\circ\text{C}$ RH=90%-95%	240Hrs	0/20
	High Temperature Storage	High $T_a=+85^\circ\text{C}\pm 5^\circ\text{C}$	1000Hrs	0/20
	Low Temperature Storage	Low $T_a=-35^\circ\text{C}\pm 5^\circ\text{C}$ Test time=1000hrs	1000Hrs	0/20
Environmental Test	Temperature Cycling	$-45^\circ\text{C}\sim +105^\circ\text{C}$ 15min 5min 15min	300 Cycles	0/20
	Thermal Shock	$-35^\circ\text{C}\sim \pm 5^\circ\text{C}\sim +85^\circ\text{C}\sim \pm 5^\circ\text{C}$ 5min 10sec 5min	300 Cycles	0/20
	Solder Resistance	Preheating: $120^\circ\text{C}-150^\circ\text{C}$, within 2 minutes. Operation heating : 260°C (Max.), within 5 seconds (Max.)	5Cycles	0/20

Judgment criteria of failure for the reliability

Measuring items	Symbol	Measuring conditions	Judgment criteria for failure
Forward voltage	$V_F(\text{V})$	$I_F=20\text{mA}$	Over $U\times 1.2$
Reverse current	$I_R(\mu\text{A})$	$V_R=5\text{V}$	Over $U\times 2$
Luminous intensity	$I_v(\text{mcd})$	$I_F=20\text{mA}$	Below $S\times 0.5$

Note: 1.U means the upper limit of specified characteristics. S means initial value.

2.Measurment shall be taken between 2 hours after the test pieces have been returned to normal ambient conditions after completion of each test.