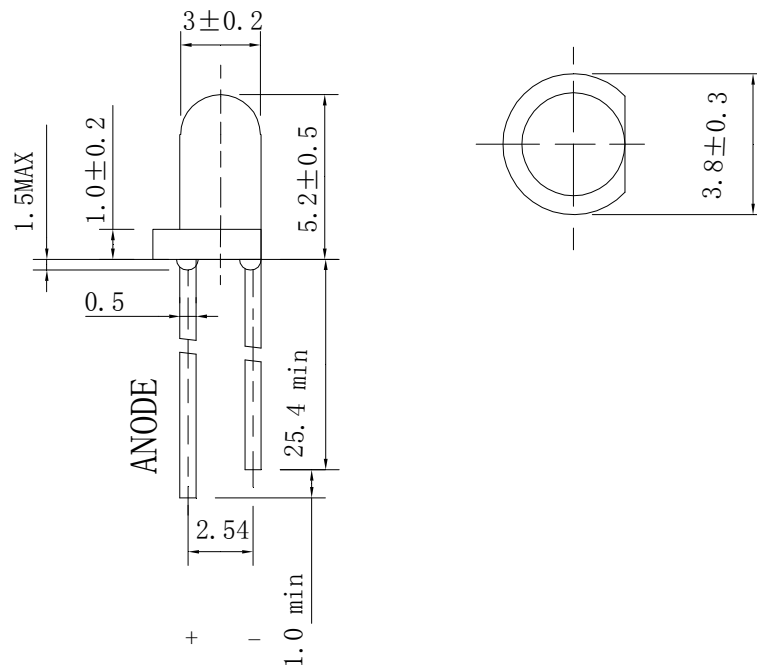

Features

- 3mm DIA LED Lamp
- Low Power Consumption
- High Efficiency
- Various Colors and Viewing Angle
- Long Solid State Reliability
- Package: 1000pcs/Packing

Applications

- Indicator

Package Dimensions**Notes:**

1. All dimensions are in millimeters (inches).
2. Tolerance is $\pm 0.25\text{mm}$ (.01") unless otherwise noted.
3. Protruded Resin under flange is 1.0mm(0.04") max.
4. Specifications are subject to change without notice.
5. This drawing is only for reference, not as a basis for the actual structure.



Selection Guide

Part No	Lens Type	Dice	Emitted Color
FDL-3521YD-ZY1	Yellow Diffused	AlInGaP	Yellow

Electrical / Optical Characteristics At Ta=25°C

Symbol	Parameter	Min.	Typ.	Max.	Unit	Test Condition
Iv	Luminous Intensity	18	60		mcd	IF=20mA
2θ1/2	Viewing Angle		30		deg	IF=20mA
λ Peak	Peak Emission Wavelength	582	588	595	nm	IF=20mA
λ d	Dominant Wavelength	585	589	595	nm	IF=20mA
Δλ	Spectral Line Half-Width		15		nm	IF=20mA
VF	Forward Voltage	1.6	2.0	2.5	V	IF=20mA
IR	Reverse Current			100	uA	VR 5V

Note:

1. θ1/2 is the angle from optical centerline where the luminous intensity is 1/2 optical centerline value

Absolute Maximum Ratings At Ta=25°C

Parameter	Yellow	Unit
Power Dissipation	75	mW
Peak Forward Current[1]	80	mA
Continuous Forward Current	30	mA
Dreading Linear From 25°C	0.4	mA/°C
Reverse Voltage	5	V
Operating Temperature Range	-55°C to + 85°C	
Storage Temperature Range	-55°C to + 85°C	
Soldering Condition	260°C For 5 Seconds	

Note:

1. 1/10 Duty Cycle, 0.1ms Pulse Width

Electrical Optical Characteristics Curves At Ta=25°C

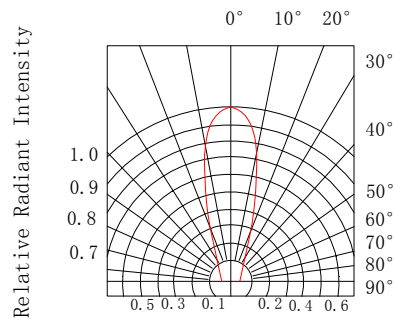
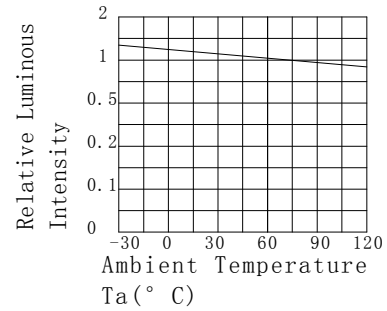
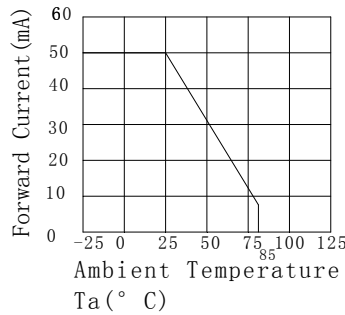
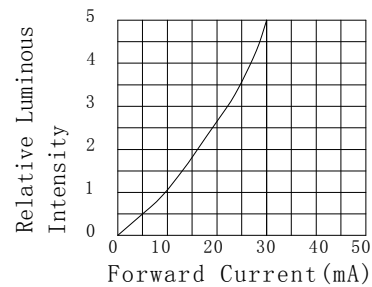
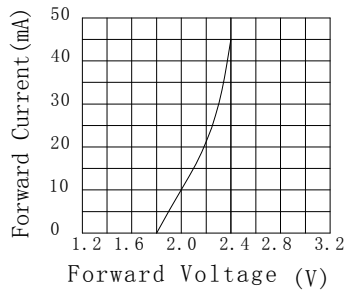
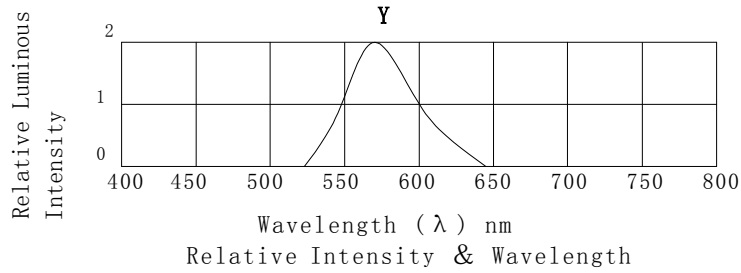

Radiation Diagram

Notes:

1. The LEDs should be used within a year.
2. The LEDs should be kept in 5~30°C and 60% RH for less.
3. The LEDs should be used within 24 hours, or else should be kept a 5~30°C and 30% RH or less. And LEDs should be used within 7 days after opening the package.

Reliability Test Items Conditions

Classification	Test Item	Test Conditions	Test hours	Result
Endurance Test	Opertion Life	Connect with a power if=20mA Ta=Under room temperature	1000Hrs	0/20
	Hige Temperature High Humidity	Ta=+ 65°C±5°C RH=90%-95%	240Hrs	0/20
	Hige Temperature Storage	High Ta=+ 85°C±5°C	1000Hrs	0/20
	Low Temperature Storage	Low Ta=-35°C±5°C Test time=1000hrs	1000Hrs	0/20
Environmental Test	Temperature Cycling	-45°C ~+105°C 15min 5min 15min	300 Cycles	0/20
	Thermal Shock	-35°C ~±5°C ~+85°C ~±5°C 5min 10sec 5min	300 Cycles	0/20
	Solder Resistance	Preheating: 120°C-150°C,within 2 minutes. Operation heating : 260°C (Max.),within5 seconds(Max.)	5Cycles	0/20

Judgment criteria of fialure for the reliability

Measuring items	Symbol	Measuring conditions	Judement criteria for failure
Forward voltage	V _F (V)	I _F =20mA	Over U×1.2
Rvevrse current	I _R (μA)	V _R =5V	Over U×2
Luminous intensity	I _v (mcd)	I _F =20mA	Below S×0.5

Note: 1.U means the upper limit of specified characteristics. S means initial value.

2.Meansurment shall be taken between 2 hours after the test pieces have been returnde to normal ambient cnditions after completion of each test.