

**Features**

- 3mm DIA LED Lamp
- Low Power Consumption
- High Efficiency
- Various Colors and Viewing Angle
- Long Solid State Reliability
- Package: 1000pcs/Packing

**Applications**

- Indicator

**Package Dimensions**

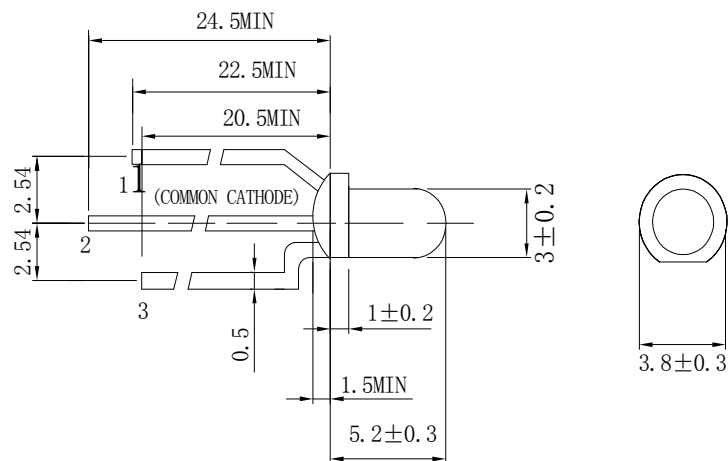

FDL-3522RB-ZWD1-CC (Common Cathode)

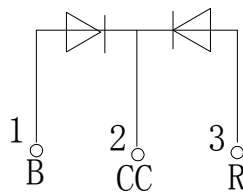

**Notes:**

1. All dimensions are in millimeters (inches).
2. Tolerance is ±0.25mm(.01") unless otherwise noted.
3. Protruded Resin under flange is 1.0mm(0.04") max.
4. Specifications are subject to change without notice.



**Selection Guide**

Part No	Lens Type	Dice	Emitted Color
FDL-3522RB-ZWD1-CC	White Diffused	GaAsP	Blue Red

**Electrical / Optical Characteristics At Ta=25°C**

Symbol	Parameter	Min.	Typ.	Max.	Unit	Test Condition
Iv	Luminous Intensity		70/60		mcd	IF=10mA
2 θ 1/2	Viewing Angle		30/30		deg	IF=20mA
λ Peak	Peak Emission Wavelength	455/615	460/620	465/625	nm	IF=20mA
Δλ	Spectral Line Half-Width	460/625	465/625	470/630	nm	IF=20mA
VF	Forward Voltage	2.5/1.8	2.6/2.2	2.8/2.4	V	IF=20mA
IR	Reverse Current		50/50		uA	VR 5V

Note:

1. Right for red color.  
Left for green color.
2. θ1/2 is the angle from optical centerline where the luminous intensity is 1/2 optical centerline value

**Absolute Maximum Ratings At Ta=25°C**

Parameter	Bule	Red	Unit
Power Dissipation	80	80	mW
Peak Forward Current[1]	150	150	mA
Continuous Forward Current	30	30	mA
Reverse Voltage	5	5	V
Electrostatic Discharge Threshold	300		V
Operating Temperature Range	-40°C to + 85°C		
Storage Temperature Range	-40°C to + 85°C		
Soldering Condition	260°C For 5 Seconds		

Note:

1. 1/10DutyCycle, 0.1ms Pulse Width

**Electrical Optical Characteristics Curves At Ta=25°C**

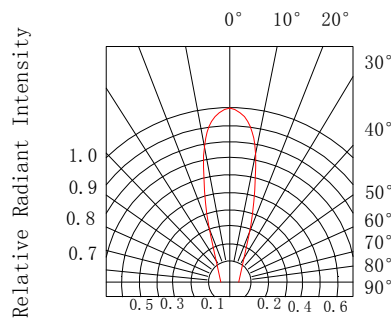
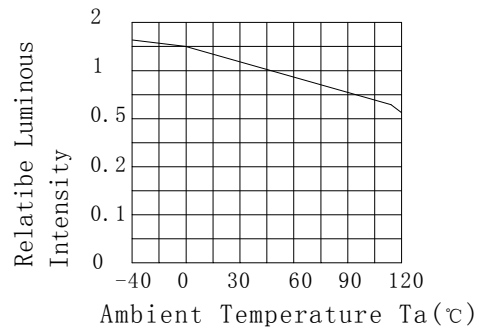
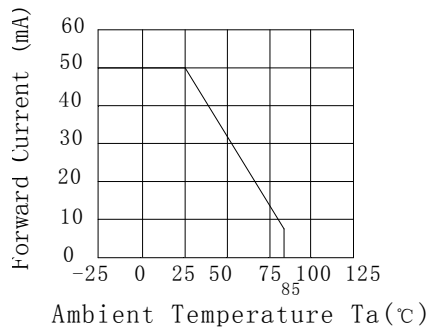
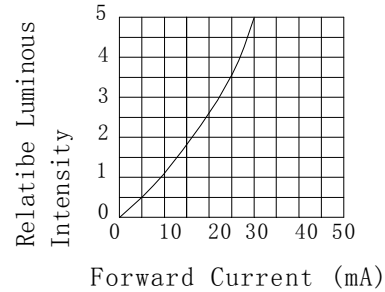
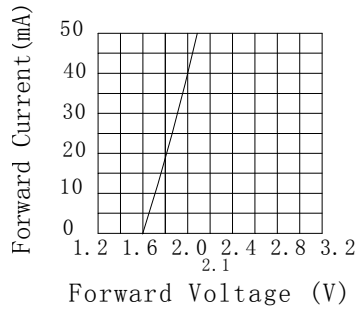
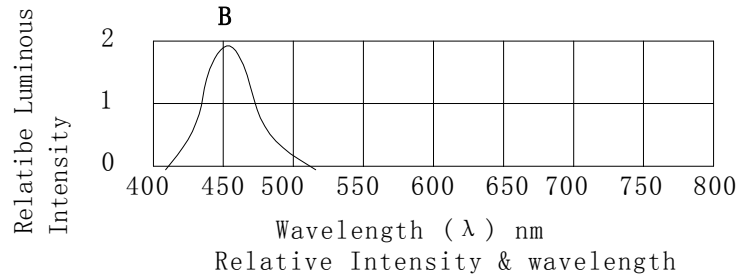

Radiation Diagram

**Electrical Optical Characteristics Curves At Ta=25°C**

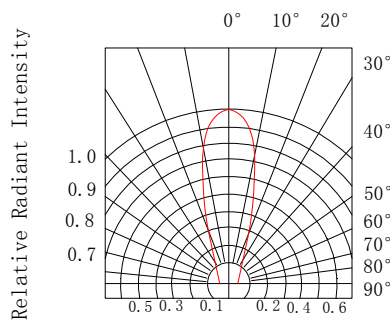
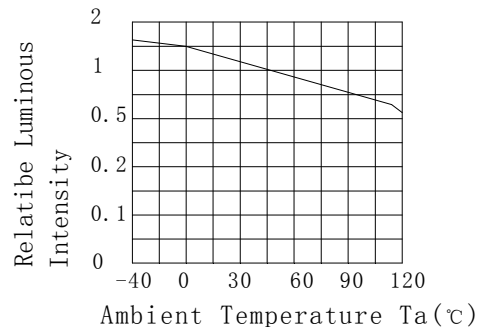
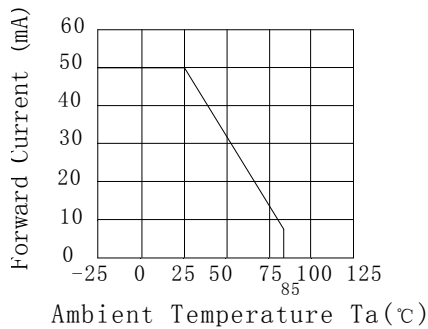
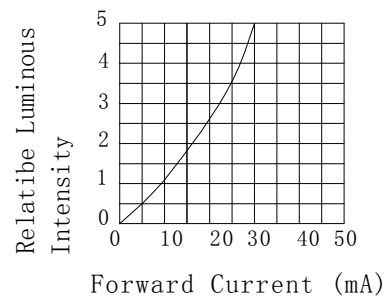
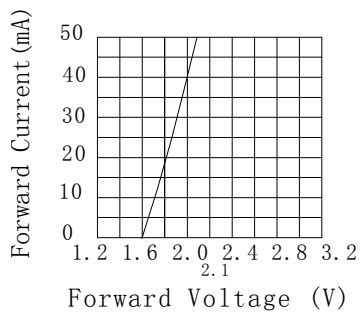
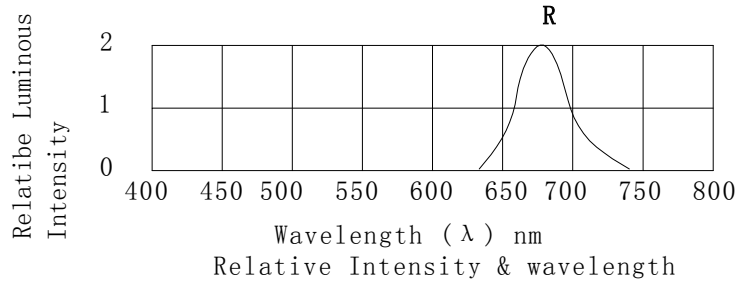

Radiation Diagram

Notes:

1. The LEDs should be used within a year.
2. The LEDs should be kept in 5~30°C and 60% RH for less.
3. The LEDs should be used within 24 hours, or else should be kept a 5~30°C and 30% RH or less. And LEDs should be used within 7 days after opening the package.

**Reliability Test Items Conditions**

Classification	Test Item	Test Conditions	Test hours	Result
Endurance Test	Opertion Life	Connect with a power if=20mA Ta=Under room temperature	1000Hrs	0/20
	Hige Temperature High Humidity	Ta=+ 65°C±5°C RH=90%-95%	240Hrs	0/20
	Hige Temperature Storage	High Ta=+ 85°C±5°C	1000Hrs	0/20
	Low Temperature Storage	Low Ta=-35°C±5°C Test time=1000hrs	1000Hrs	0/20
Environmental Test	Temperature Cycling	-45°C ~+105°C 15min 5min 15min	300 Cycles	0/20
	Thermal Shock	-35°C ~±5°C ~+85°C ~±5°C 5min 10sec 5min	300 Cycles	0/20
	Solder Resistance	Preheating: 120°C-150°C,within 2 minutes. Operation heating : 260°C (Max.),within5 seconds(Max.)	5Cycles	0/20

**Judgment criteria of fialure for the reliability**

Measuring items	Symbol	Measuring conditions	Judement criteria for failure
Forward voltage	V <sub>F</sub> (V)	I <sub>F</sub> =20mA	Over U×1.2
Rvevrse current	I <sub>R</sub> (μA)	V <sub>R</sub> =5V	Over U×2
Luminous intensity	I <sub>v</sub> (mcd)	I <sub>F</sub> =20mA	Below S×0.5

Note: 1.U means the upper limit of specified characteristics. S means initial value.

2.Meansurment shall be taken between 2 hours after the test pieces have been returnde to normal ambient cnditions after completion of each test.