

**Features**

- 3mm DIA LED Lamp
- Low Power Consumption
- High Efficiency
- Various Colors and Viewing Angle
- Long Solid State Reliability
- Package: 1000pcs/Packing

**Applications**

- Indicator

**Package Dimensions**

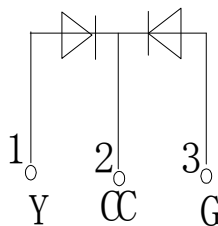
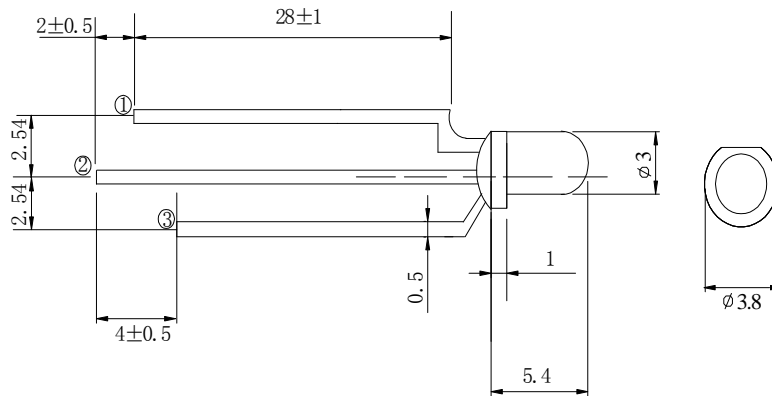

**Notes:**

1. All dimensions are in millimeters (inches).
2. Tolerance is  $\pm 0.25$ mm (.01") unless otherwise noted.
3. Protruded Resin under flange is 1.0mm(0.04") max.
4. Specifications are subject to change without notice.

www.FantasyLeds.com

Sales@FantasyLeds.com



**Selection Guide**

Part No	Lens Type	Dice	Emitted Color
FDL-3522YG-ZWD1-CC	White Diffused	AlInGaP GaAsP	Yellow Green

**Electrical / Optical Characteristics At Ta=25°C**

Symbol	Parameter		Yellow	Green	Unit	Test Condition
Iv	Luminous Intensity	MIN.	28.0	20.0	mcd	IF=20mA
		TYP.	45.0	35.0		
2θ1/2	Viewing Angle	TYP.	30	30	deg	IF=20mA
λ Peak	Peak Emission Wavelength	TYP.	591	573	nm	IF=20mA
λ d	Dominant Wavelength	TYP.	589	570	nm	IF=20mA
Δλ	Spectral Line Half-Width	TYP.	15	20	nm	IF=20mA
VF	Forward Voltage	TYP.	2.0	2.1	V	IF=20mA
		MAX.	2.4	2.6		
IR	Reverse Current	MAX.	10	10	μ A	VR 5V

Note:

1.θ1/2 is the angle from optical centerline where the luminous intensity is 1/2 optical centerline value

**Absolute Maximum Ratings At Ta=25°C**

Parameter	Yellow	Green	Unit
Power Dissipation	80	80	mW
Peak Forward Current[1]	150	150	mA
Continuous Forward Current	30	30	mA
Reverse Voltage	5	5	V
Operating Temperature Range	-40°C to + 85°C		
Storage Temperature Range	-40°C to + 85°C		
Soldering Condition	260°C For 5 Seconds		

Note:

1. 1/10DutyCycle, 0.1ms Pulse Width

**Electrical Optical Characteristics Curves At Ta=25°C**

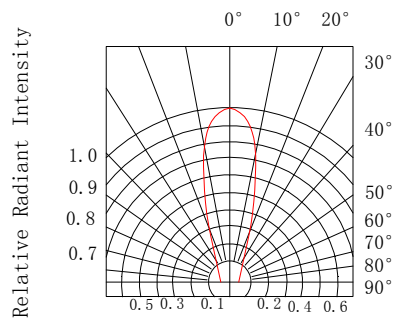
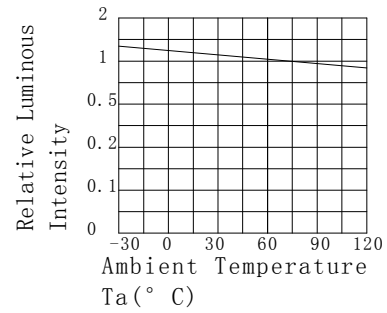
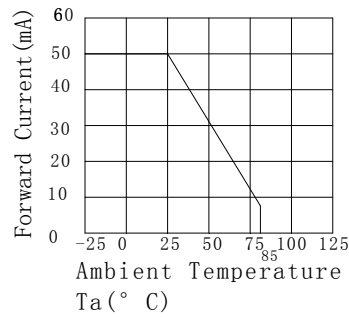
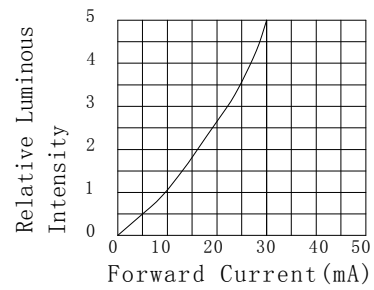
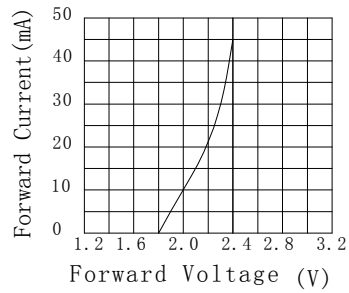
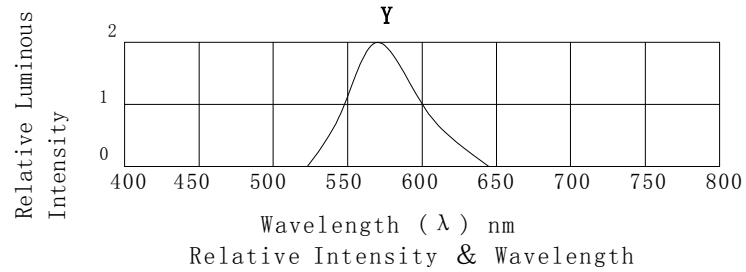

Radiation Diagram

**Electrical Optical Characteristics Curves At Ta=25°C**

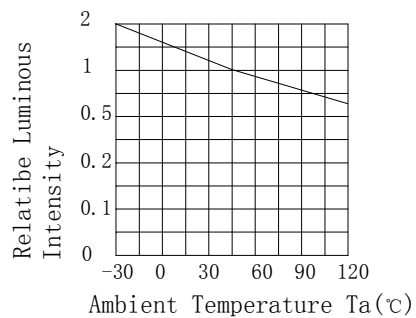
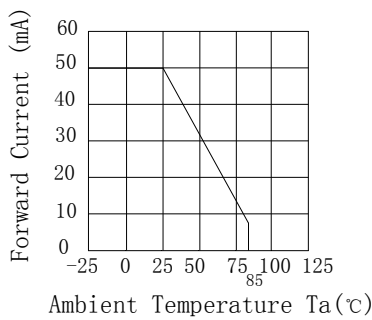
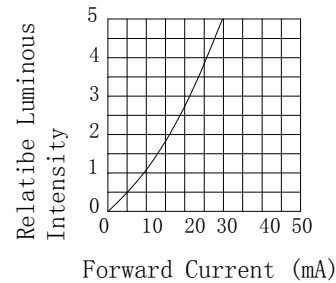
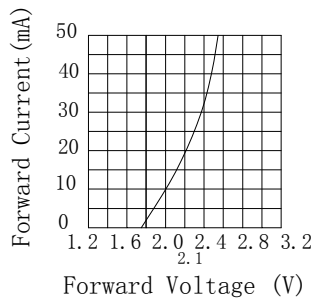
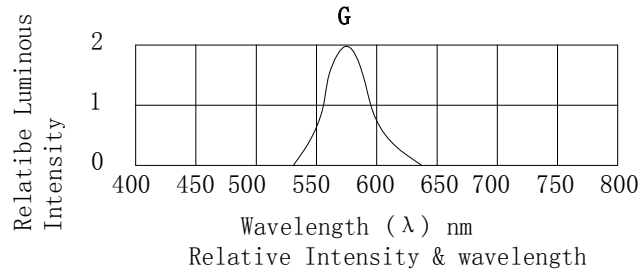

**Notes:**

1. The LEDs should be used within a year.
2. The LEDs should be kept in 5~30°C and 60% RH for less.
3. The LEDs should be used within 24 hours, or else should be kept a 5~30°C and 30% RH or less. And LEDs should be used within 7 days after opening the package.

**Reliability Test Items Conditions**

Classification	Test Item	Test Conditions	Test hours	Result
Endurance Test	Opertion Life	Connect with a power $I_F=20mA$ $T_a$ =Under room temperature	1000Hrs	0/20
	Hige Temperature High Humidity	$T_a=+65^{\circ}C\pm5^{\circ}C$ RH=90%-95%	240Hrs	0/20
	Hige Temperature Storage	High $T_a=+85^{\circ}C\pm5^{\circ}C$	1000Hrs	0/20
	Low Temperature Storage	Low $T_a=-35^{\circ}C\pm5^{\circ}C$ Test time=1000hrs	1000Hrs	0/20
Environmental Test	Temperature Cycling	$-45^{\circ}C \sim +105^{\circ}C$ 15min 5min 15min	300 Cycles	0/20
	Thermal Shock	$-35^{\circ}C \sim \pm5^{\circ}C \sim +85^{\circ}C \sim \pm5^{\circ}C$ 5min 10sec 5min	300 Cycles	0/20
	Solder Resistance	Preheating: $120^{\circ}C-150^{\circ}C$ ,within 2 minutes. Operation heating : $260^{\circ}C$ (Max.),within5 seconds(Max.)	5Cycles	0/20

**Judgment criteria of failure for the reliability**

Measuring items	Symbol	Measuring conditions	Judgment criteria for failure
Forward voltage	$V_F(V)$	$I_F=20mA$	Over $U \times 1.2$
Rvevrse current	$I_R(\mu A)$	$V_R=5V$	Over $U \times 2$
Luminous intensity	$I_v(mcd)$	$I_F=20mA$	Below $S \times 0.5$

Note: 1.U means the upper limit of specified characteristics. S means initial value.

2.Measurment shall be taken between 2 hours after the test pieces have been returned to normal ambient conditions after completion of each test.