

Features

- 3mm DIA LED Lamp
- Low Power Consumption
- High Efficiency
- Various Colors and Viewing Angle
- Long Solid State Reliability
- Package: 1000pcs/Packing

Applications

- Indicator

Package Dimensions

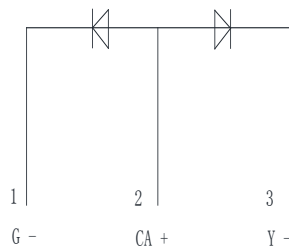
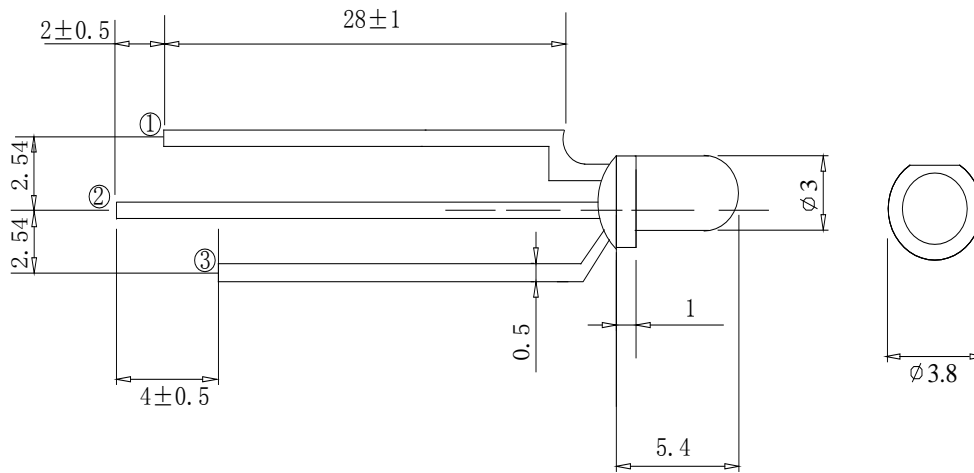

Notes:

1. All dimensions are in millimeters (inches).
2. Tolerance is ±0.25mm(.01") unless otherwise noted.
3. Protruded Resin under flange is 1.0mm(0.04") max.
4. Specifications are subject to change without notice.



Selection Guide

Part No	Lens Type	Dice	Emitted Color
FDL-3523GY-ZWWDP-CA	White Diffused	GaAsP	Yellow Green

Electrical / Optical Characteristics At Ta=25 °C

Symbol	Parameter		Yellow	Green	Unit	Test Condition
Iv	Luminous Intensity	MIN.			mcd	IF=20mA
		TYP.	15.0	10.0		
2θ1/2	Viewing Angle	TYP.	30	30	deg	IF=20mA
λ Peak	Peak Emission Wavelength	TYP.	588	574	nm	IF=20mA
λ d	Dominant Wavelength	TYP.	590	570	nm	IF=20mA
Δλ	Spectral Line Half-Width	TYP.	20	20	nm	IF=20mA
VF	Forward Voltage	TYP.	2.1	2.1	V	IF=20mA
		MAX.	2.7	2.7		
IR	Reverse Current	MAX.	10	10	μ A	VR 5V

Note:

1 θ1/2 is the angle from optical centerline where the luminous intensity is 1/2 optical centerline value

Absolute Maximum Ratings At Ta=25°C

Parameter	Yellow	Green	Unit
Power Dissipation	80	80	mW
Peak Forward Current[1]	150	150	mA
Continuous Forward Current	30	30	mA
Reverse Voltage	5	5	V
Operating Temperature Range	-40°C to + 85°C		
Storage Temperature Range	-40°C to + 85°C		
Soldering Condition	260°C For 5 Seconds		

Note:

1. 1/10DutyCycle, 0.1ms Pulse Width

Electrical Optical Characteristics Curves At Ta=25 °C

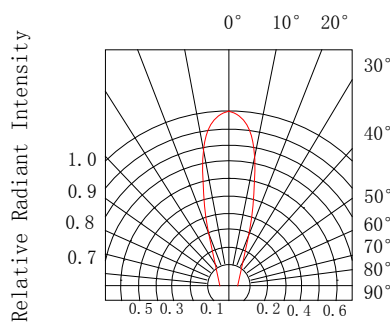
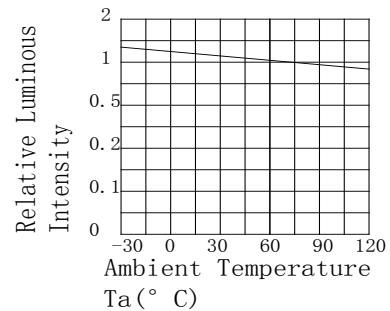
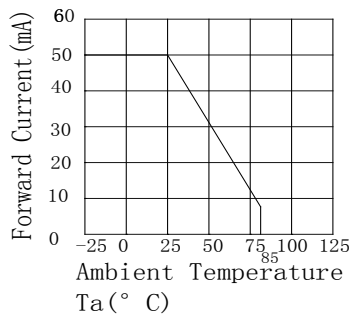
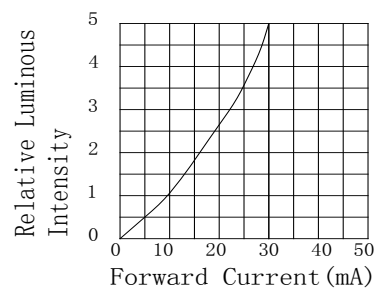
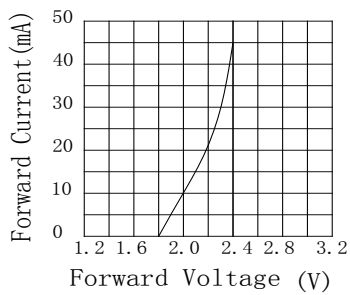
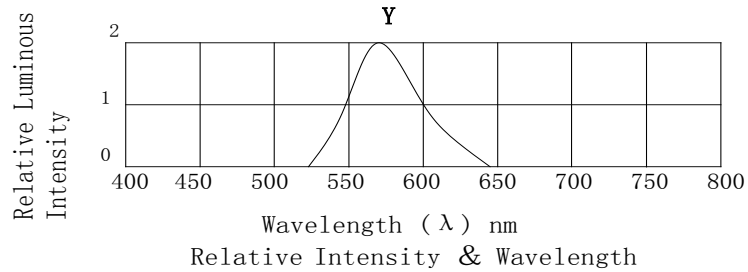

Radiation Diagram

Notes:

1. The LEDs should be used within a year.
2. The LEDs should be kept in 5~30°C and 60% RH for less.
3. The LEDs should be used within 24 hours, or else should be kept a 5~30°C and 30% RH or less. And LEDs should be used within 7 days after opening the package.

Electrical Optical Characteristics Curves At Ta=25 °C

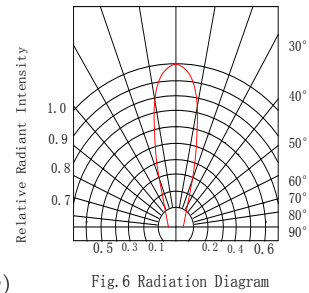
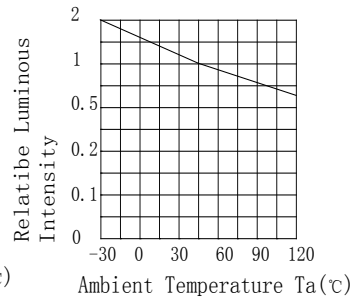
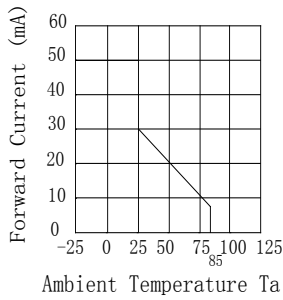
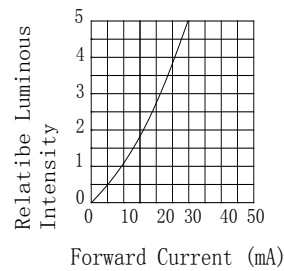
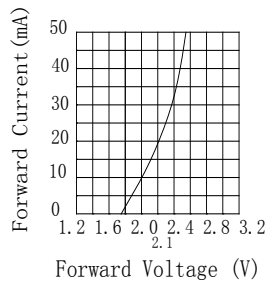
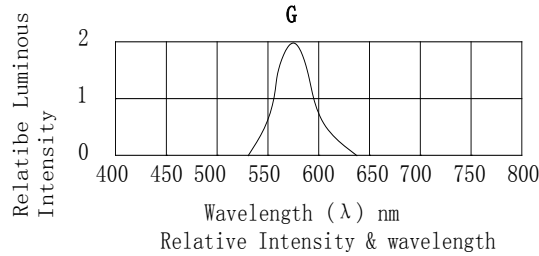

Reflow Soldering Instructions

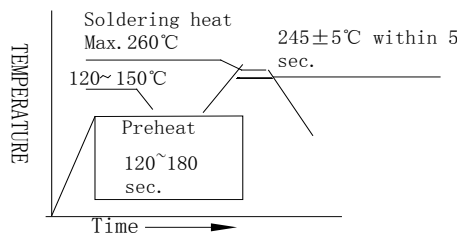

Notes:

4. The LEDs should be used within a year.
5. The LEDs should be kept in 5~30°C and 60% RH for less.
6. The LEDs should be used within 24 hours, or else should be kept a 5~30°C and 30% RH or less. And LEDs should be used within 7 days after opening the package.

Reliability Test Items Conditions

Classification	Test Item	Test Conditions	Test hours	Result
Endurance Test	Operation Life	Connect with a power $I_F=20\text{mA}$ $T_a=\text{Under room temperature}$	1000Hrs	0/20
	High Temperature High Humidity	$T_a=+65^\circ\text{C}\pm 5^\circ\text{C}$ RH=90%-95%	240Hrs	0/20
	High Temperature Storage	High $T_a=+85^\circ\text{C}\pm 5^\circ\text{C}$	1000Hrs	0/20
	Low Temperature Storage	Low $T_a=-35^\circ\text{C}\pm 5^\circ\text{C}$ Test time=1000hrs	1000Hrs	0/20
Environmental Test	Temperature Cycling	$-45^\circ\text{C} \sim +105^\circ\text{C}$ 15min 5min 15min	300 Cycles	0/20
	Thermal Shock	$-35^\circ\text{C} \sim \pm 5^\circ\text{C} \sim +85^\circ\text{C} \sim \pm 5^\circ\text{C}$ 5min 10sec 5min	300 Cycles	0/20
	Solder Resistance	Preheating: $120^\circ\text{C} - 150^\circ\text{C}$, within 2 minutes. Operation heating : 260°C (Max.), within 5 seconds (Max.)	5Cycles	0/20

Judgment criteria of failure for the reliability

Measuring items	Symbol	Measuring conditions	Judgment criteria for failure
Forward voltage	$V_F(\text{V})$	$I_F=20\text{mA}$	Over $U \times 1.2$
Reverse current	$I_R(\mu\text{A})$	$V_R=5\text{V}$	Over $U \times 2$
Luminous intensity	$I_v(\text{mcd})$	$I_F=20\text{mA}$	Below $S \times 0.5$

Note: 1.U means the upper limit of specified characteristics. S means initial value.

2.Measurement shall be taken between 2 hours after the test pieces have been returned to normal ambient conditions after completion of each test.