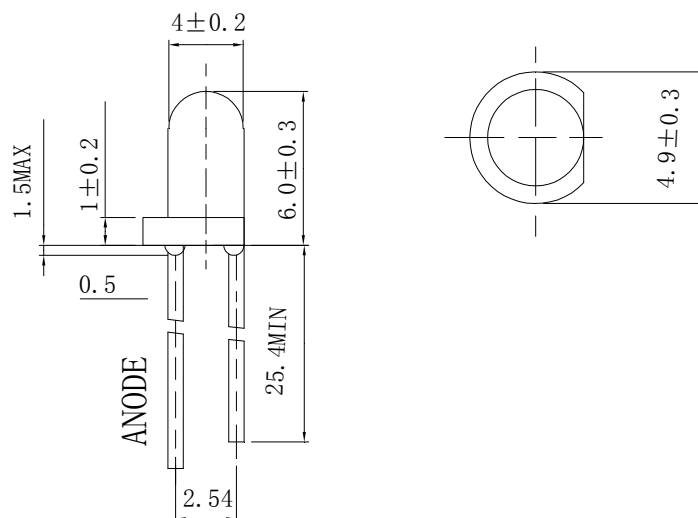

**Features**

- 4mm DIA LED Lamp
- Low Power Consumption
- High Efficiency
- Various Colors and Viewing Angle
- Long Solid State Reliability
- Package: 1000pcs/Packing

**Applications**

- Indicator

**Package Dimensions****Notes:**

1. All dimensions are in millimeters (inches).
2. Tolerance is  $\pm 0.25\text{mm}$  (.01") unless otherwise noted.
3. Protruded Resin under flange is 1.0mm (0.04") max.
4. Specifications are subject to change without notice.



**Selection Guide**

Part No	Lens Type	Dice	Emitted Color
FDL-4601Y-ZYBDL	Yellow Diffused	AlInGaP	Yellow

**Electrical / Optical Characteristics At Ta=25°C**

Symbol	Parameter	Min.	Typ.	Max.	Unit	Test Condition
Iv	Luminous Intensity	28	57		mcd	IF=20mA
2θ1/2	Viewing Angle		90		deg	IF=20mA
λ Peak	Peak Emission Wavelength		588		nm	IF=20mA
λ d	Dominant Wavelength		592		nm	IF=20mA
Δλ	Spectral Line Half-Width		15		nm	IF=20mA
VF	Forward Voltage		2.0	2.4	V	IF=20mA
IR	Reverse Current			5	uA	VR 5V

Note:

1. θ1/2 is the angle from optical centerline where the luminous intensity is 1/2 optical centerline value

**Absolute Maximum Ratings At Ta=25°C**

Parameter	Yellow	Unit
Power Dissipation	75	mW
Peak Forward Current[1]	80	mA
Continuous Forward Current	30	mA
Dreading Linear From 25°C	0.4	mA/°C
Reverse Voltage	5	V
Operating Temperature Range	-55°C to + 85°C	
Storage Temperature Range	-55°C to + 85°C	
Soldering Condition	260°C For 5 Seconds	

Note:

1. 1/10 Duty Cycle, 0.1ms Pulse Width

**Electrical Optical Characteristics Curves At Ta=25°C**

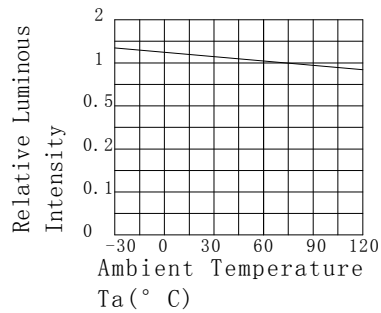
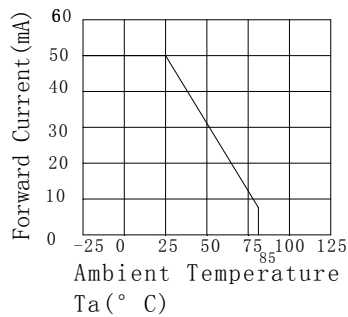
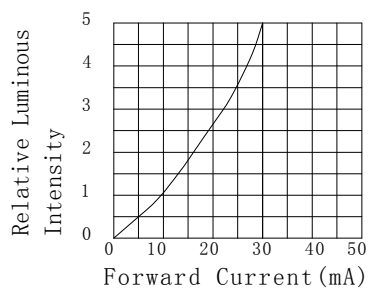
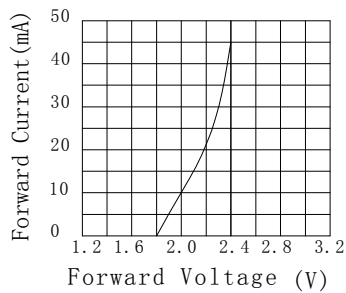
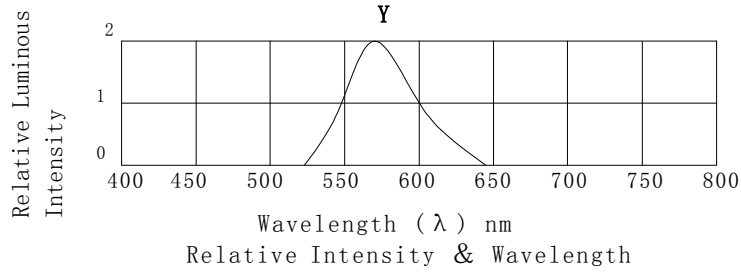

**Reflow Soldering Instructions**

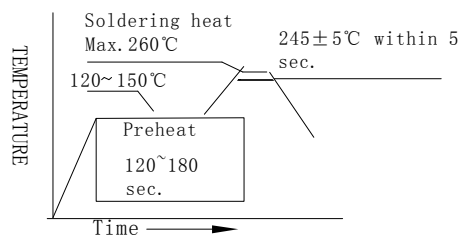

**Notes:**

1. The LEDs should be used within a year.
2. The LEDs should be kept in 5~30°C and 60% RH for less.
3. The LEDs should be used within 24 hours, or else should be kept a 5~30°C and 30% RH or less. And LEDs should be used within 7 days after opening the package.

**Reliability Test Items Conditions**

Classification	Test Item	Test Conditions	Test hours	Result
Endurance Test	Opertion Life	Connect with a power if=20mA Ta=Under room temperature	1000Hrs	0/20
	Hige Temperature High Humidity	Ta= +65°C±5°C RH=90%-95%	240Hrs	0/20
	Hige Temperature Storage	High Ta= +85°C±5°C	1000Hrs	0/20
	Low Temperature Storage	Low Ta=-35°C±5°C Test time=1000hrs	1000Hrs	0/20
Environmental Test	Temperature Cycling	-45°C ~ +105°C 15min 5min 15min	300 Cycles	0/20
	Thermal Shock	-35°C ~ ±5°C ~ +85°C ~ ±5°C 5min 10sec 5min	300 Cycles	0/20
	Solder Resistance	Preheating: 120°C-150°C, within 2 minutes. Operation heating : 260°C (Max.), within 5 seconds (Max.)	5Cycles	0/20

**Judgment criteria of fialure for the reliability**

Measuring items	Symbol	Measuring conditions	Judement criteria for failure
Forward voltage	V <sub>F</sub> (V)	I <sub>F</sub> =20mA	Over U×1.2
Rvevrse current	I <sub>R</sub> (μA)	V <sub>R</sub> =5V	Over U×2
Luminous intensity	I <sub>v</sub> (mcd)	I <sub>F</sub> =20mA	Below S×0.5

Note: 1.U means the upper limit of specified characteristics. S means initial value.

2.Meansurment shall be taken between 2 hours after the test pieces have been returnde to normal ambient cnditions after completion of each test.