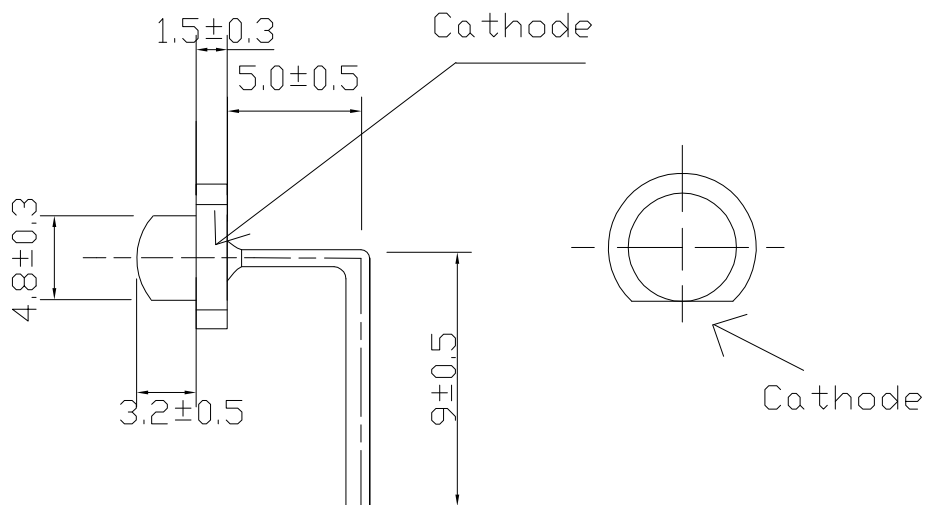

Features

- 4.8mm DIA LED Lamp
- Low Power Consumption
- High Efficiency
- Various Colors and Viewing Angle
- Long Solid State Reliability
- Package: 1000pcs/Packing

Applications

- Indicator

Package Dimensions**Notes:**

1. All dimensions are in millimeters (inches).
2. Tolerance is ± 0.25 mm (.01") unless otherwise noted.
3. Protruded Resin under flange is 1.0mm (0.04") max.
4. Specifications are subject to change without notice.



Selection Guide

Part No	Lens Type	Dice	Emitted Color
FDL-4847HW-YHD-D5.0-9	Water Clear	InGaALN	White

Electrical / Optical Characteristics At Ta=25°C

Symbol	Parameter	Min.	Typ.	Max.	Unit	Test Condition
Iv	Luminous Intensity	900		1800	mcd	IF=20mA
2θ1/2	Viewing Angle		110		deg	IF=20mA
λ Peak	Peak Emission Wavelength		-		nm	IF=20mA
X/Y	Chrotral Coordinage		0.33/0.34		nm	IF=20mA
△λ	Spectral Line Half-Width		30		nm	IF=20mA
VF	Forward Voltage	2.8	3.3	3.7	V	IF=20mA
IR	Reverse Current			50	μ A	VR 5V

Note:

1. θ1/2 is the angle from optical centerline where the luminous intensity is 1/2 optical centerline value

Absolute Maximum Ratings At Ta=25°C

Parameter	White	Unit
Power Dissipation	100	mW
Peak Forward Current[1]	60	mA
Continuous Forward Current	30	mA
Reverse Voltage	5	V
Electrostatic Discharge Threshold(HBM)	1000	V
Operating Temperature Range	-20°C to + 80°C	
Storage Temperature Range	-40°C to + 100°C	
Soldering Condition	260°C For 5 Seconds	

Note:

1. 1/10DutyCycle, 0.1msPulseWidth

Electrical Optical Characteristics Curves At Ta=25°C

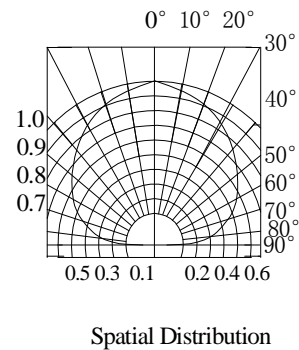
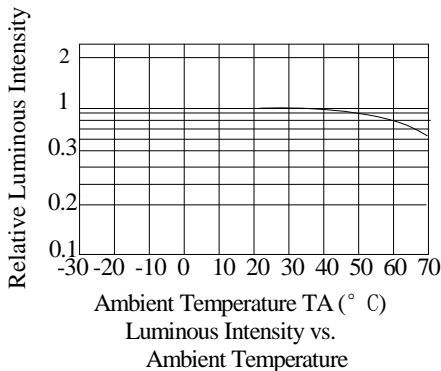
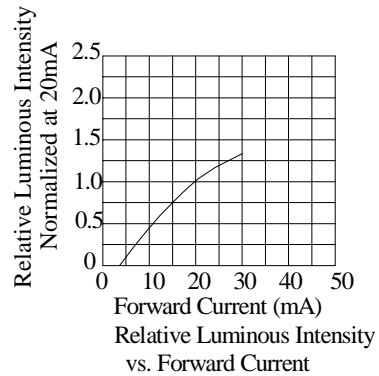
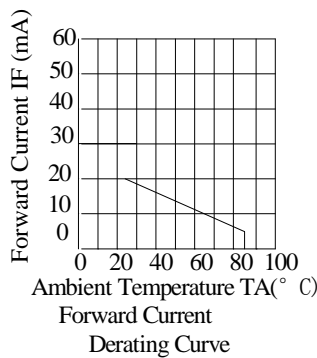
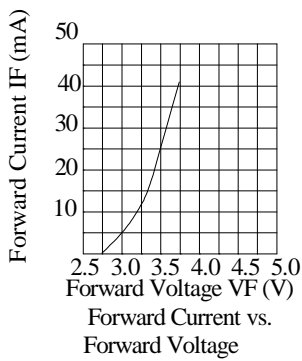
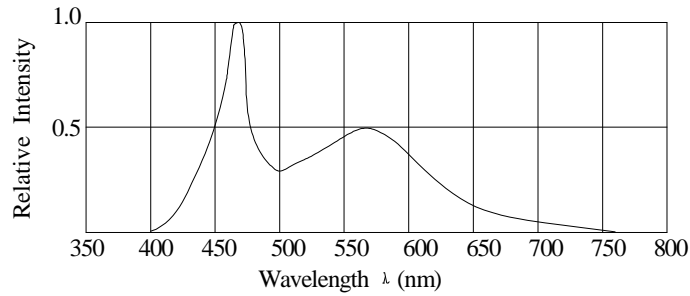

Reflow Soldering Instructions

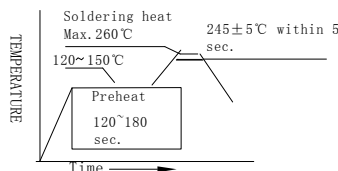

Notes:

1. The LEDs should be used within a year.
2. The LEDs should be kept in 5~30°C and 60% RH for less.
3. The LEDs should be used within 24 hours, or else should be kept a 5~30°C and 30% RH or less. And LEDs should be used within 7 days after opening the package.

Bin Range Of Luminous Intensity (+/-15%)

Symbol	Bin Code	Min.	Max.	Unit	Condition
Iv	H1	900	1120	mcd	IF=20mA
	H2	1120	1450		
	H3	1450	1800		

Bin Range Of Forward Voltage (+/-0.1)

Symbol	Bin Code	Min.	Max.	Unit	Condition
VF	V328	2.8	3.1	V	IF=20mA
	V331	3.1	3.4		
	V334	3.4	3.7		

Chromaticity Coordinates Specifications for Bin Grading (+/-0.05)

IF=20mA

Bin	CIE_x	CIE_y	Bin	CIE_x	CIE_y	Bin	CIE_x	CIE_y
B	0.287	0.295	W	0.307	0.315	Y	0.33	0.36
	0.307	0.315		0.33	0.339		0.361	0.385
	0.311	0.294		0.33	0.318		0.355	0.35
	0.296	0.276		0.311	0.294		0.33	0.318

CIE Chromaticity Diagram

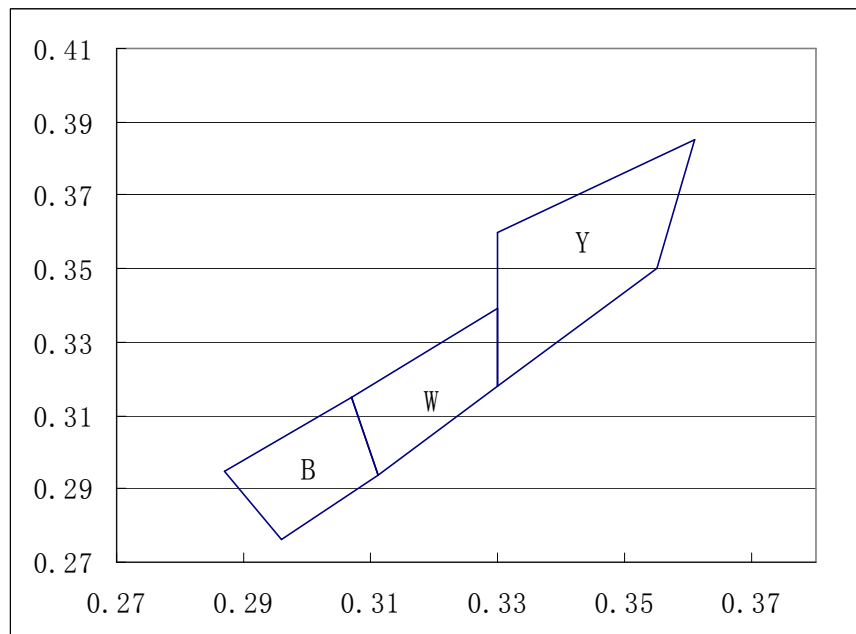

Reliability Test Items Conditions

Classification	Test Item	Test Conditions	Test hours	Result
Endurance Test	Opertion Life	Connect with a power if=20mA Ta=Under room temperature	1000Hrs	0/20
	Hige Temperature High Humidity	Ta=+ 65°C±5°C RH=90%-95%	240Hrs	0/20
	Hige Temperature Storage	High Ta=+ 85°C±5°C	1000Hrs	0/20
	Low Temperature Storage	Low Ta=-35°C±5°C Test time=1000hrs	1000Hrs	0/20
Environmental Test	Temperature Cycling	-45°C ~+105°C 15min 5min 15min	300 Cycles	0/20
	Thermal Shock	-35°C ~±5°C ~+85°C ~±5°C 5min 10sec 5min	300 Cycles	0/20
	Solder Resistance	Preheating: 120°C-150°C, within 2 minutes. Operation heating : 260°C (Max.), within 5 seconds (Max.)	5Cycles	0/20

Judgment criteria of fialure for the reliability

Measuring items	Symbol	Measuring conditions	Judement criteria for failure
Forward voltage	V _F (V)	I _F =20mA	Over U×1.2
Rvevrse current	I _R (μA)	V _R =5V	Over U×2
Luminous intensity	I _v (mcd)	I _F =20mA	Below S×0.5

Note: 1.U means the upper limit of specified characteristics. S means initial value.

2.Meansurment shall be taken between 2 hours after the test pieces have been returnde to normal ambient cnditions after completion of each test.