

Features

- 1.6mm*0.8mm SMT LED, Super thin (0.4H mm)
- Low Power Consumption
- Wide Viewing Angle
- Various Colors
- Compatible with automatic placement equipment.
- Compatible with infrared and vapor phase reflow and wave solder process.
- Meet ROHS Green Product
- Package: 3000pcs/Reel

Applications

- Backlight and Indicator

Package Dimensions

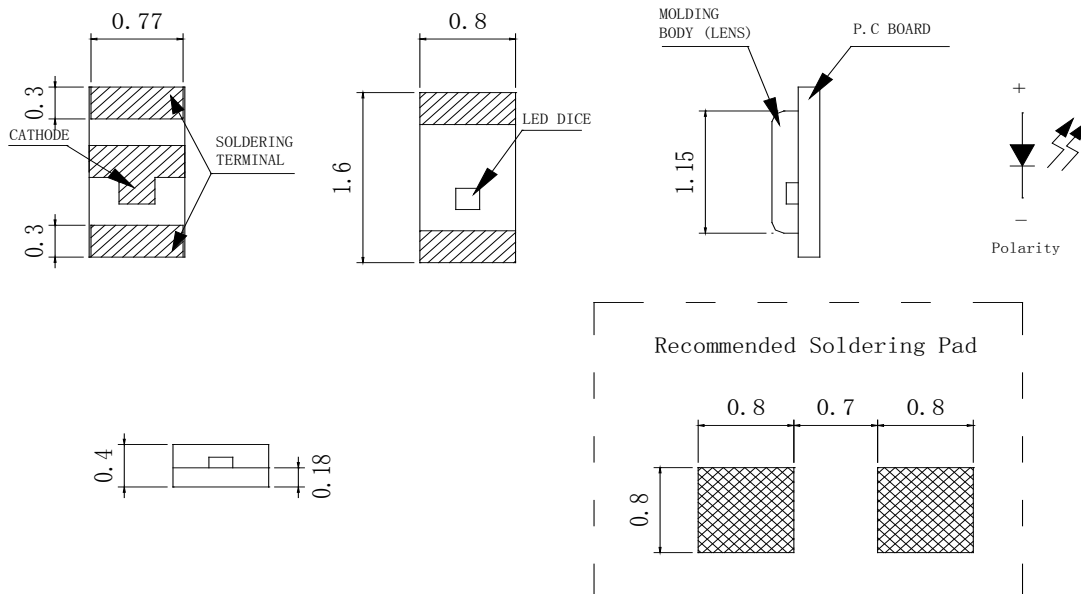

Notes:

1. All dimensions are in millimeters (inches).
2. Tolerance is $\pm 0.2\text{mm}$ (.0079") unless otherwise noted.
3. Specifications are subject to change without notice
4. This drawing is only for reference, not as a basis for the actual structure.

**Selection Guide**

| Part No | Lens Type | Dice | Emitted Color |
|----------------------|-------------|---------|---------------|
| FSL-1608040R-FAT5NC3 | Water Clear | AlInGaP | Red |

Electrical / Optical Characteristics At Ta=25 °C

| Symbol | Parameter | Min. | Typ. | Max. | Unit | Test Condition |
|--------|--------------------------|-------|-------|-------|------|----------------|
| Iv | Luminous Intensity | 11.2 | 45.5 | | mcd | IF=5mA |
| 2θ1/2 | Viewing Angle | | 130 | | deg | IF=5mA |
| λ Peak | Peak Emission Wavelength | | 632.0 | | nm | IF=5mA |
| λ d | Dominant Wavelength | 617.5 | 631.0 | 637.5 | nm | IF=5mA |
| Δλ | Spectral Line Half-Width | | 20 | | nm | IF=5mA |
| VF | Forward Voltage | 1.5 | 2.0 | 2.3 | V | IF=5mA |
| IR | Reverse Current | | | 10 | μ A | VR=5V |

Note:

1. θ1/2 is the angle from optical centerline where the luminous intensity is 1/2 optical centerline value

Absolute Maximum Ratings At Ta=25°C

| Parameter | Red | Unit |
|--|----------------------|-------|
| Power Dissipation | 45 | mW |
| Peak Forward Current[1] | 60 | mA |
| Continuous Forward Current | 20 | mA |
| Dreading Linear From25°C | 0.4 | mA/°C |
| Reverse Voltage | 5 | V |
| Electrostatic Discharge Threshold(HBM) | 2000 | V |
| Operating Temperature Range | -45°C to + 85°C | |
| Storage Temperature Range | -55°C to + 105°C | |
| Soldering Condition | 260°C For 10 Seconds | |

Note:

1. 1/10DutyCycle, 0.1msPulseWidth

Electrical Optical Characteristics Curves At Ta=25 °C

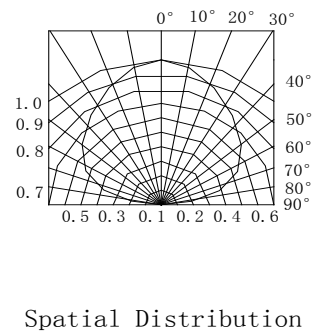
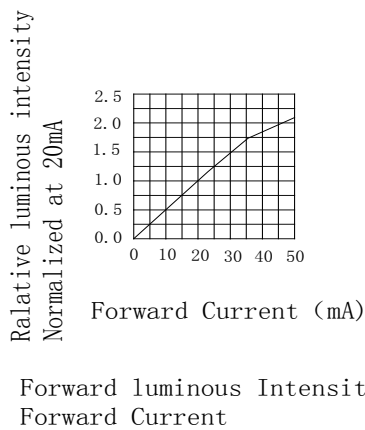
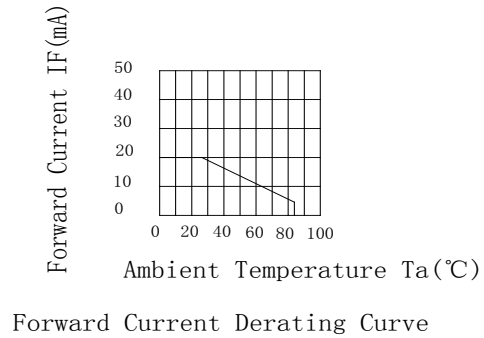
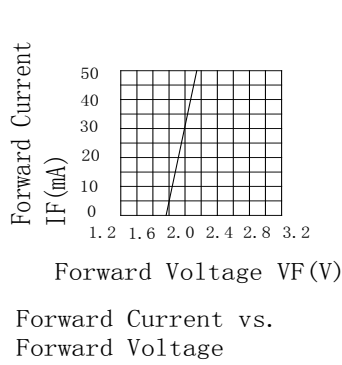
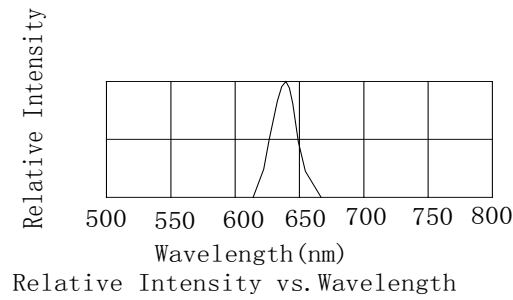

Bin Range Of Luminous Intensity

| Symbol | Bin Code | Min. | Max. | Unit | Condition |
|--------|----------|------|------|------|-----------|
| Iv | L | 11.2 | 18 | mcd | IF=5mA |
| | M | 18 | 28 | | |
| | N | 28 | 45 | | |
| | P | 45 | 72 | | |

Bin Range Of Forward Voltage

| Symbol | Bin Code | Min. | Max. | Unit | Condition |
|--------|----------|------|------|------|-----------|
| VF | V15 | 1.5 | 1.7 | V | IF=5mA |
| | V17 | 1.7 | 1.9 | | |
| | V19 | 1.9 | 2.1 | | |
| | V21 | 2.1 | 2.3 | | |
| | V23 | 2.3 | 2.5 | | |

Bin Range Of Dominate Wavelength

| Symbol | Bin Code | Min. | Max. | Unit | Condition |
|-------------|----------|-------|-------|------|-----------|
| λd | R1 | 617.5 | 621.5 | nm | IF=5mA |
| | R2 | 621.5 | 625.5 | | |
| | R3 | 625.5 | 629.5 | | |
| | R4 | 629.5 | 633.5 | | |
| | R5 | 633.5 | 637.5 | | |

Notes:

1. Tolerance of Luminous Intensity +/-20%
2. Tolerance of Forward Voltage +/-0.15V
3. Tolerance of the Dominate Wavelength +/- 2nm

SMT Reflow Soldering Instructions

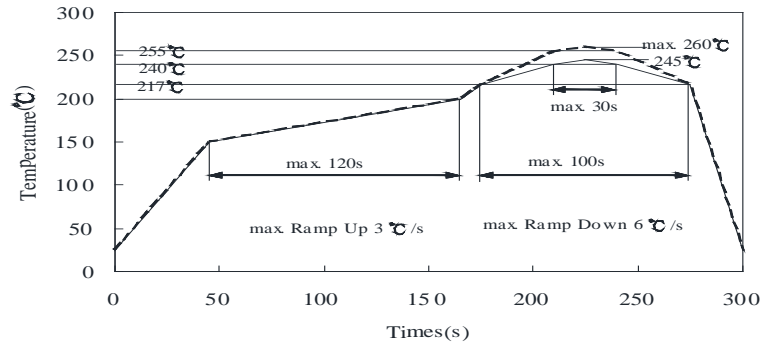

Notes:

1. Selles gives no other assurances regarding the ability of to withstand ESD. It is recommended to use a wrist band or anti-electrostatic glove when handling the LED. All devices, equipment and machinery must be properly grounded.
2. Reflow soldering should not be done more than two times.
3. Do not stress LED when soldering, and do not warp the circuit board after soldering
4. While using Iron, Power dissipation of Iron should be smaller than 25W, and temperature should be controllable. The work should be finished within 2 sec under 320°C for once only.

Application

In order to ensure intensity uniformity on multiple LEDs connected in parallel in an application, it is recommended to use individual resistor separately, as shown in Circuit A below. The brightness of each LED shown in Circuit B might appear difference due to the differences in the I-V characteristics of those LEDs.

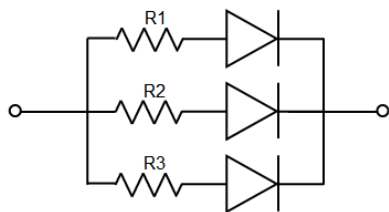

Circuit model A

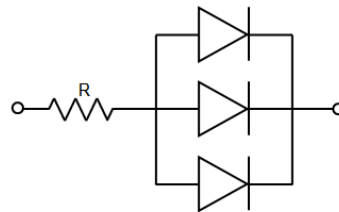

Circuit model B

Reel Dimensions

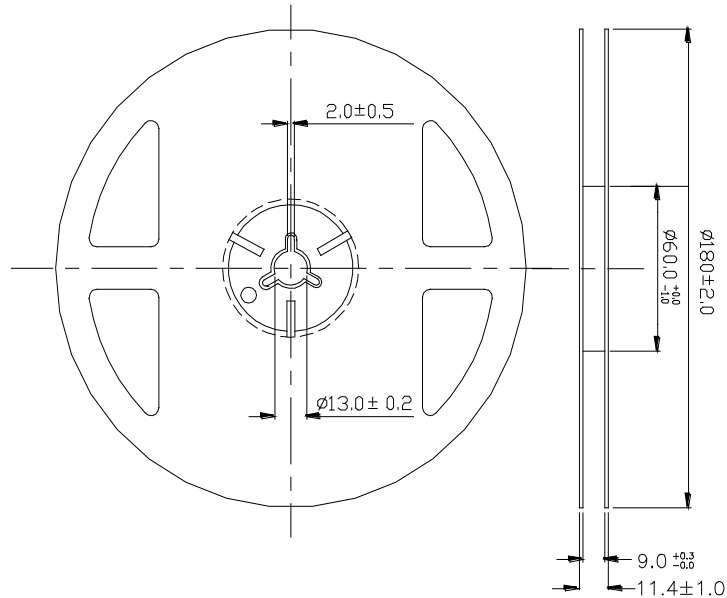

Package Specifications (Units: mm(inches))

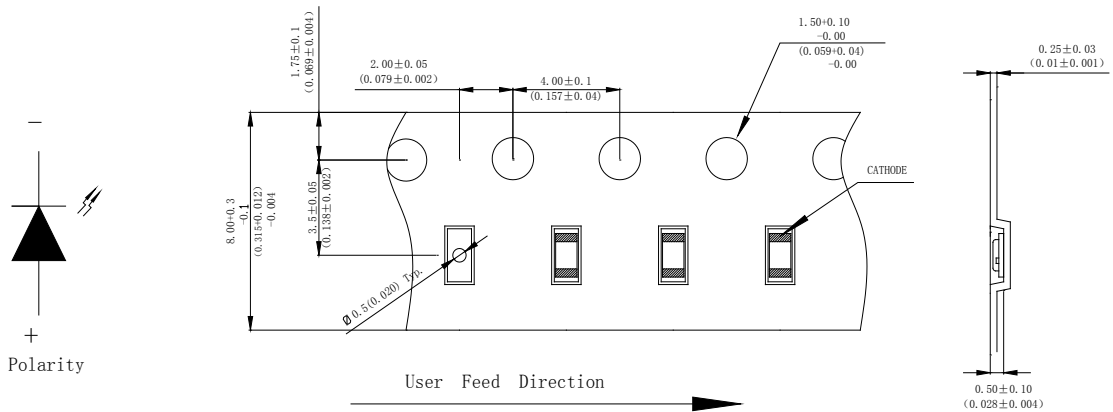

Notes:

1. The LEDs should be used within a year.
2. The LEDs should be kept in 5~30°C and 60% RH for less.
3. The LEDs should be used within 24 hours, or else should be kept a 5~30°C and 30% RH or less. And LEDs should be used within 7 days after opening the package.

Reliability Test Items Conditions

| Classification | Test Item | Test Conditions | Test hours | Result |
|--------------------|-----------------------------------|---|------------|--------|
| Endurance Test | Operation Life | Connect with a power $I_F=5mA$ T_a =Under room temperature | 1000Hrs | 0/20 |
| | High Temperature High Humidity | $T_a=+65^{\circ}C\pm5^{\circ}C$ RH=90%-95% | 240Hrs | 0/20 |
| | High Temperature Storage | High $T_a=+100^{\circ}C\pm5^{\circ}C$ | 1000Hrs | 0/20 |
| | Low Temperature Storage | Low $T_a=-50^{\circ}C\pm5^{\circ}C$ Test time=1000hrs | 1000Hrs | 0/20 |
| Environmental Test | Temperature Cycling | $-50^{\circ}C\sim+105^{\circ}C$ 15min 5min 15min | 300 Cycles | 0/20 |
| | Thermal Shock | $-45^{\circ}C\sim\pm5^{\circ}C\sim+85^{\circ}C\sim\pm5^{\circ}C$ 5min 10sec 5min | 300 Cycles | 0/20 |
| | Solder Resistance | Preheating: $120^{\circ}C-150^{\circ}C$, within 2 minutes. Operation heating : $260^{\circ}C$ (Max.), within 10 seconds(Max.) | 5Cycles | 0/20 |

Judgment criteria of failure for the reliability

| Measuring items | Symbol | Measuring conditions | Judgment criteria for failure |
|--------------------|--------------|----------------------|-------------------------------|
| Forward voltage | $V_F(V)$ | $I_F=5mA$ | Over $U\times 1.2$ |
| Reverse current | $I_R(\mu A)$ | $V_R=5V$ | Over $U\times 2$ |
| Luminous intensity | $I_v(mcd)$ | $I_F=5mA$ | Below $S\times 0.5$ |

Note: 1.U means the upper limit of specified characteristics. S means initial value.

2.Measurment shall be taken between 2 hours after the test pieces have been returned to normal ambient conditions after completion of each test.

Moisture Resistant Packaging

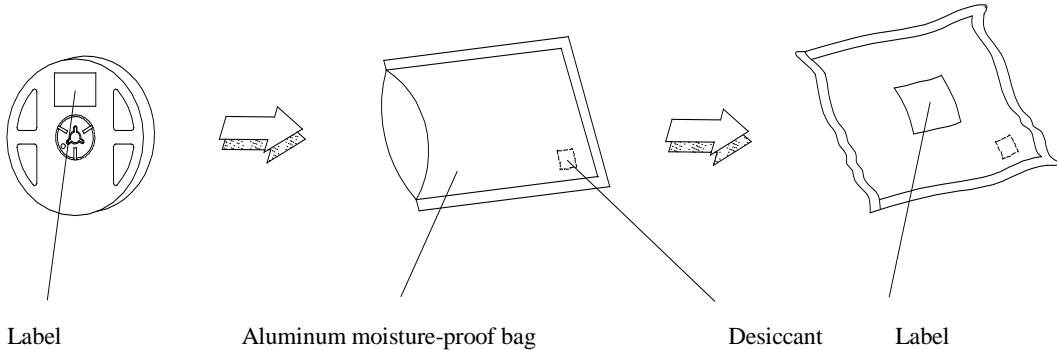

Remark: Add Desiccant into Aluminum moisture-proof bag

Label Explanation

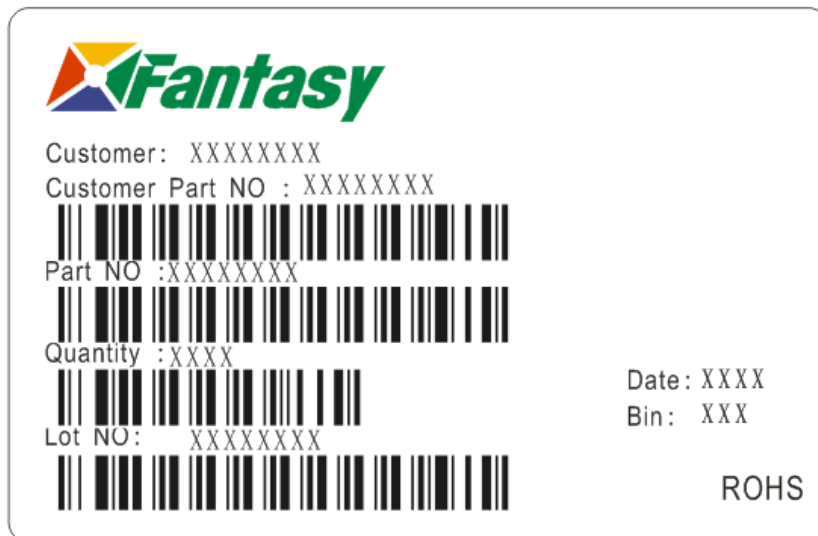

Customer: Customer Name
 Customer Part NO: Customer's Product Number
 Part NO : Fantasy Product Number
 Quantity : Packing Quantity
 Lot NO : Lot Number
 Date : Product Date (Week)
 Bin: Rank of Luminous Intensity ,Dom. Wavelength, Forward Voltage