

**Features**

- 1.6mm\*0.8mm SMT LED, Super thin (0.50H mm)
- Low Power Consumption
- Wide Viewing Angle
- Various Colors
- Compatible with automatic placement equipment.
- Compatible with infrared and vapor phase reflow and wave solder process.
- Meet ROHS Green Products
- Package: 3000pcs/Reel

**Applications**

- Backlight and Indicator

**Package Dimensions**

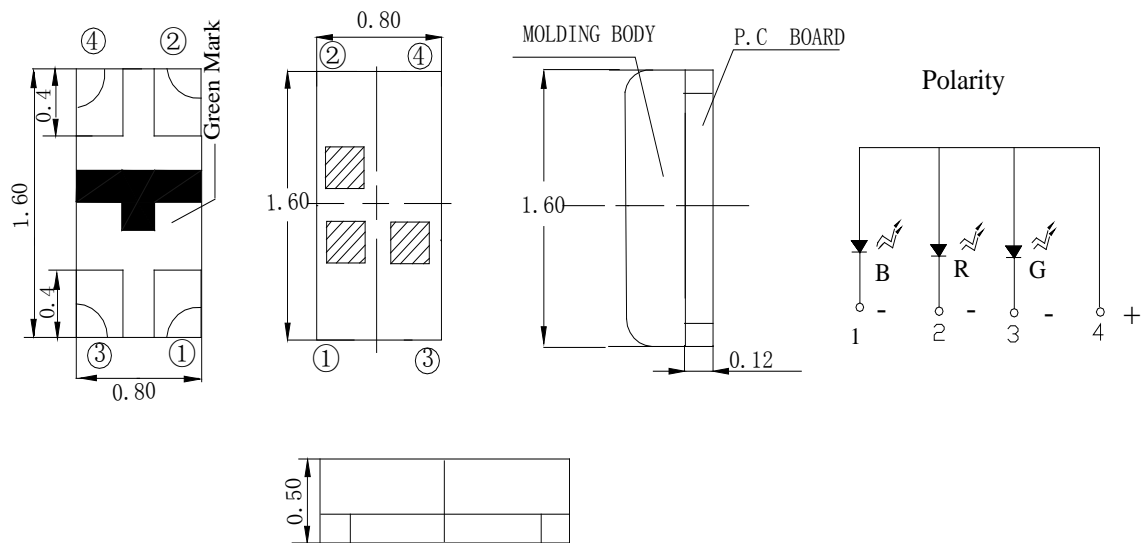

**Notes:**

1. All dimensions are in millimeters (inches).
2. Tolerance is  $\pm 0.2\text{mm}$  (.0079") unless otherwise noted.
3. Specifications are subject to change without notice
4. This drawing is only for indication, not as a basis for the actual structure.



**Selection Guide**

Part No	Lens Type	Dice	Emitted Color
FSL-1608050RPGb-FAT1N-4CA	Water Clear	AlInGaP	Red
		InGaN	Pure Green
		InGaN	Blue

**Electrical / Optical Characteristics At Ta=25 °C**

Symbol	Parameter		Red	Pure Green	Blue	Unit	Test Condition
Iv	Luminous Intensity	MIN.	3.6	5.6	1.5	mcd	IF=1mA
		TYP.	5.6	9.0	4.5		
2θ1/2	Viewing Angle	TYP.	130	130	130	deg	IF=1mA
λ Peak	Peak Emission Wavelength	TYP.	639	525	468	nm	IF=1mA
λ d	Dominant Wavelength	TYP.	631	530	470	nm	IF=1mA
Δλ	Spectral Line Half-Width	TYP.	20	35	35	nm	IF=1mA
VF	Forward Voltage	TYP.	1.7	2.6	2.6	V	IF=1mA
		MAX.	2.2	3.2	3.2		
IR	Reverse Current	MAX.	10	10	10	uA	VR=5V

Note:

1. θ1/2 is the angle from optical centerline where the luminous intensity is 1/2 optical centerline value

**Absolute Maximum Ratings At Ta=25°C**

Parameter	Red	Pure Green	Blue	Unit
Power Dissipation	3	5	5	mW
Peak Forward Current[1]	60	100	100	mA
Continuous Forward Current	25	25	25	mA
Dreading Linear From 25°C	0.4	0.5	0.25	mA/°C
Reverse Voltage	5	5	5	V
Electrostatic Discharge Threshold	2000	150	150	V
Operating Temperature Range	-20°C to + 80°C			
Storage Temperature Range	-30°C to + 100°C			
Soldering Condition	260°C For 5 Seconds			

Note:

1. 1/10DutyCycle, 0.1msPulseWidth

Electrical Optical Characteristics Curves At Ta=25 °C

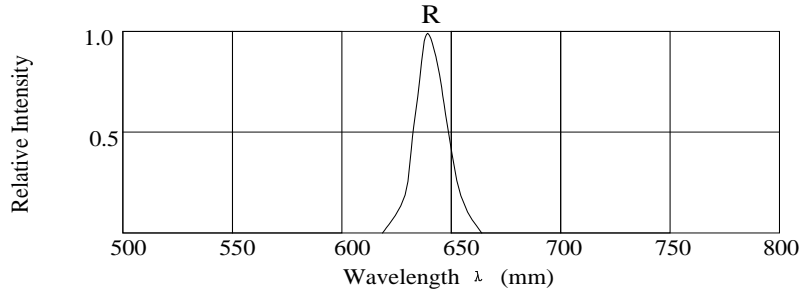

Fig.1 Relative Intensity vs. Wavelength

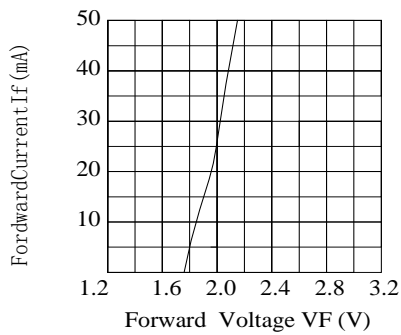

Fig.2 Forward Current VS. Forward Voltage

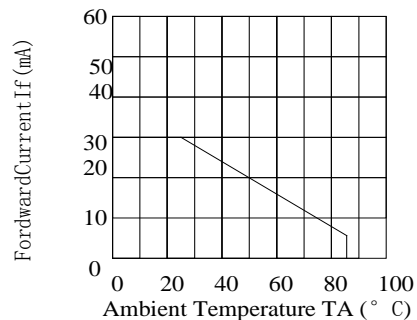

Fig.3 Forward Current Derating Curve

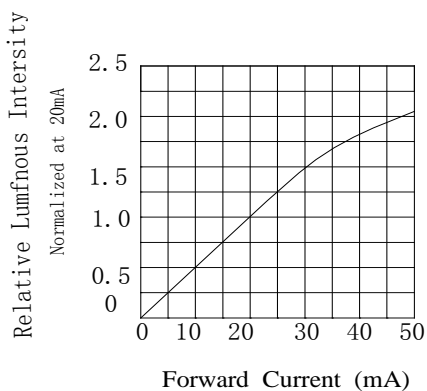

Fig.4 Relative Luminous Intensity vs. Forward Current

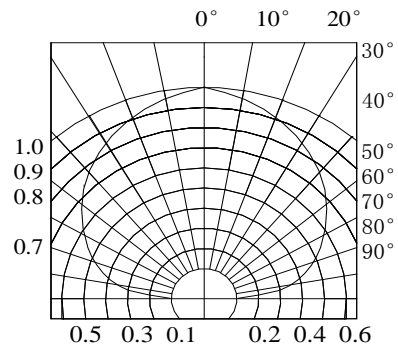

Fig.6 Spatial Distribution

**Electrical Optical Characteristics Curves At Ta=25 °C**

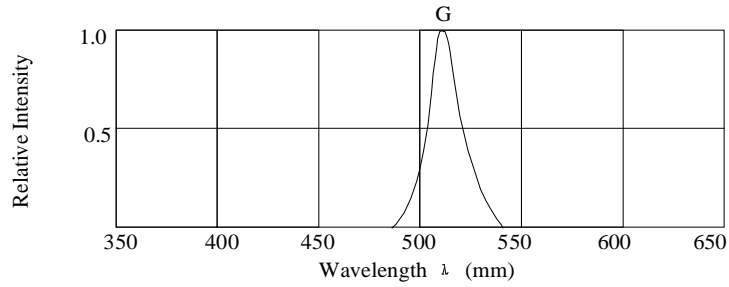

Fig.1 Relative Intensity vs. Wavelength

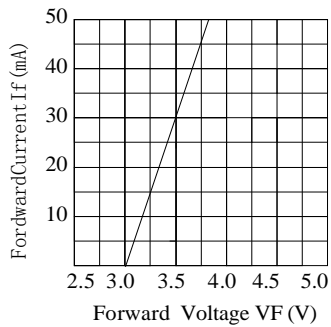

Fig.2 Forward Current VS. Forward Voltage

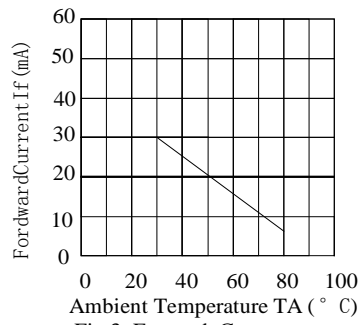

Fig.3 Forward Current Derating Curve

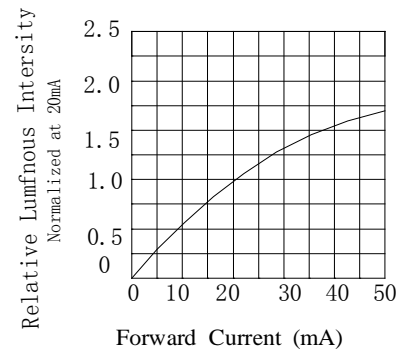

Fig.4 Relative Luminous Intensity vs. Forward Current

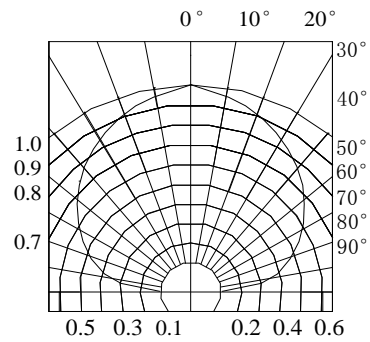
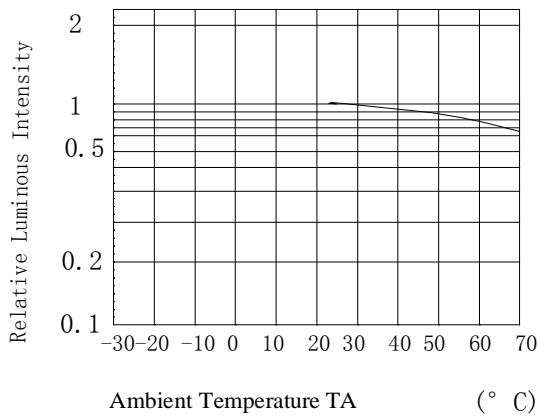

Fig.6 Spatial Distribution

**Electrical Optical Characteristics Curves At Ta=25 °C**

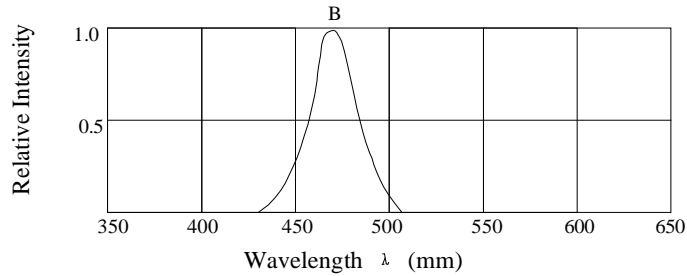

Fig.1 Relative Intensity vs. Wavelength

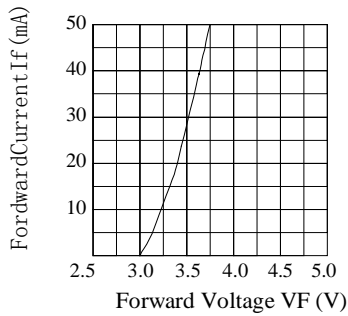

Fig.2 Forward Current VS. Forward Voltage

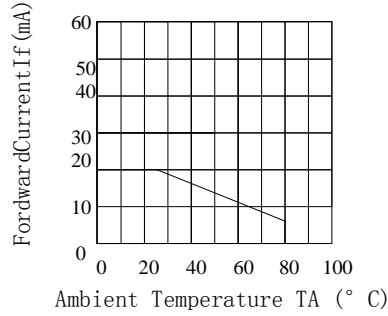

Fig.3 Forward Current Derating Curve

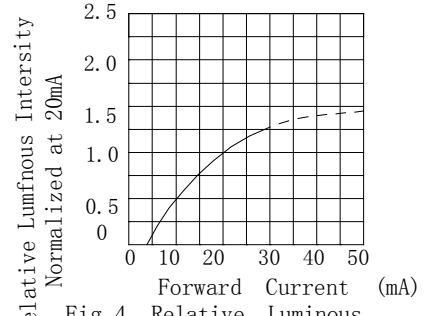

Fig.4 Relative Luminous Intensity VS. Forward Current

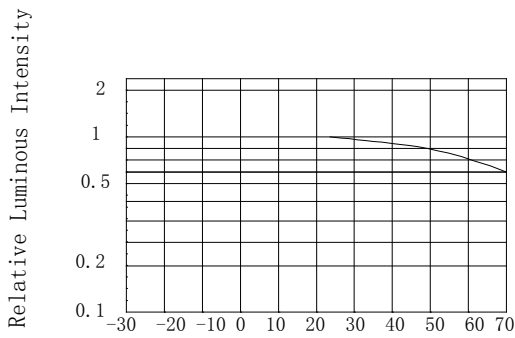

Fig.5 Luminous Intensity VS. Ambient Temperature TA

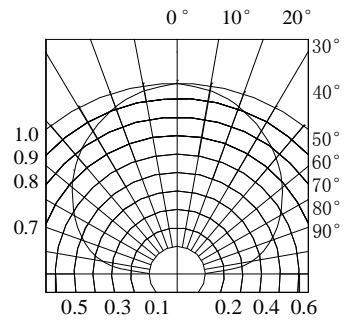
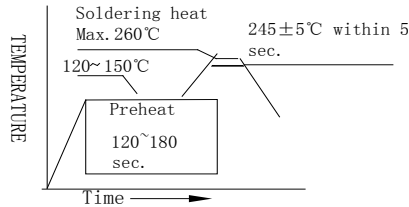

Fig.6 Spatial Distribution

**SMT Reflow Soldering Instructions**



**Notes:**

1. Sells gives no other assurances regarding the ability of to withstand ESD. It is recommended to use a wrist band or anti-electrostatic glove when handling the LED. All devices, equipment and machinery must be properly grounded.
2. Reflow soldering should not be done more than two times.
3. Do not stress LED when soldering, and do not warp the circuit board after soldering
4. While using Iron, Power dissipation of Iron should be smaller than 25W, and temperature should be controllable. The work should be finished within 2 sec under 320°C for once only.

**Recommended Soldering Pad Dimensions**

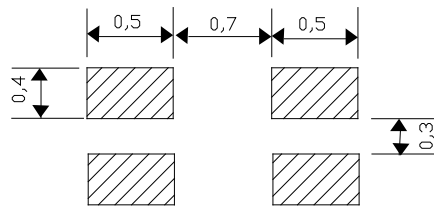

**Package Specifications (Units: mm (inches))**

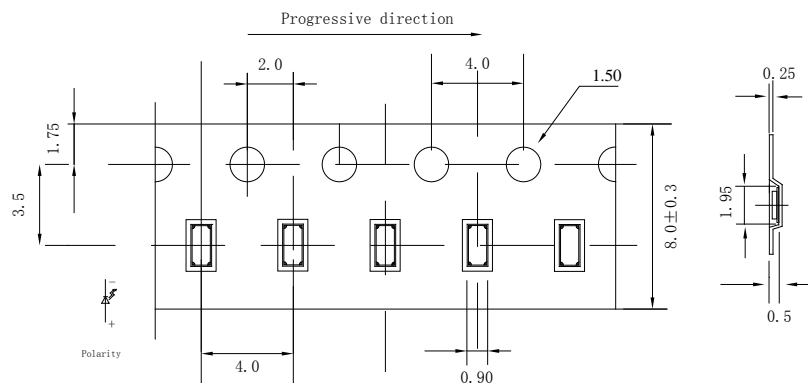

**Notes:**

1. The LEDs should be used within a year.
2. The LEDs should be kept in 5~30°C and 60% RH for less.
3. The LEDs should be used within 24 hours, or else should be kept in 5~30°C and 30% RH or less. And LEDs should be used within 7 days after opening the package.

**Reliability Test Items Conditions**

Classification	Test Item	Test Conditions	Test hours	Result
Endurance Test	Operation Life	Connect with a power $I_f=20mA$ $T_a$ =Under room temperature	1000Hrs	0/20
	High Temperature High Humidity	$T_a=+65^{\circ}C\pm5^{\circ}C$ RH=90%-95%	240Hrs	0/20
	High Temperature Storage	High $T_a=+85^{\circ}C\pm5^{\circ}C$	1000Hrs	0/20
	Low Temperature Storage	Low $T_a=-35^{\circ}C\pm5^{\circ}C$ Test time=1000hrs	1000Hrs	0/20
Environmental Test	Temperature Cycling	$-45^{\circ}C \sim +105^{\circ}C$ 15min 5min 15min	300 Cycles	0/20
	Thermal Shock	$-35^{\circ}C \sim \pm5^{\circ}C \sim +85^{\circ}C \sim \pm5^{\circ}C$ 5min 10sec 5min	300 Cycles	0/20
	Solder Resistance	Preheating: $120^{\circ}C-150^{\circ}C$ , within 2 minutes. Operation heating : $260^{\circ}C$ (Max.), within 5 seconds (Max.)	5Cycles	0/20

**Judgment criteria of failure for the reliability**

Measuring items	Symbol	Measuring conditions	Judgment criteria for failure
Forward voltage	$V_F(V)$	$I_F=20mA$	Over $U \times 1.2$
Reverse current	$I_R(\mu A)$	$V_R=5V$	Over $U \times 2$
Luminous intensity	$I_v(mcd)$	$I_F=20mA$	Below $S \times 0.5$

Note: 1. U means the upper limit of specified characteristics. S means initial value.

2. Measurement shall be taken between 2 hours after the test pieces have been returned to normal ambient conditions after completion of each test.