

Features

- 1.6mm*0.8mm SMT LED, Super thin (0.55H mm)
- Low Power Consumption
- Wide Viewing Angle
- Various Colors
- Compatible with automatic placement equipment.
- Compatible with infrared and vapor phase reflow and wave solder process.
- Meet ROHS Green Product.
- Package: 3000pcs/Reel

Applications

- Backlight and Indicator

Package Dimensions

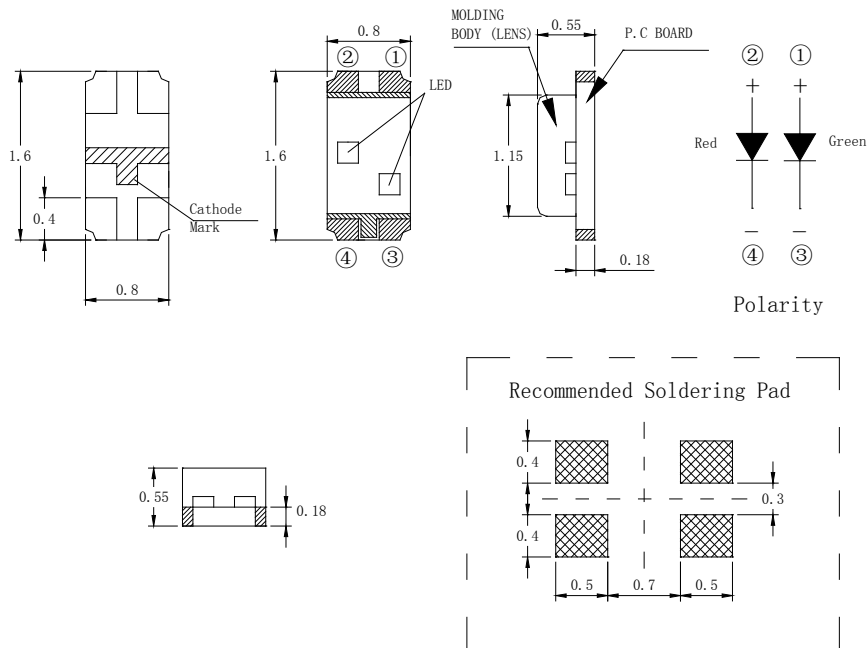

Notes:

1. All dimensions are in millimeters (inches).
2. Tolerance is $\pm 0.2\text{mm}$ (.0079") unless otherwise noted.
3. Specifications are subject to change without notice
4. This drawing is only for reference, not as a basis for the actual structure.



Selection Guide

Part No	Lens Type	Dice	Emitted Color
FSL-1608055GR-FATNC3	Water Clear	AlInGaP AlInGaP	Green Red

Electrical / Optical Characteristics At Ta=25 °C

Symbol	Parameter		Green	Red	Unit	Test Condition
Iv	Luminous Intensity	MIN.	18.0	28.0	mcd	IF=20mA
		TYP.	35.0	120.0		
		MAX.				
2θ1/2	Viewing Angle	TYP.	130	130	deg	IF=20mA
λ Peak	Peak Emission Wavelength	TYP.	574	632	nm	IF=20mA
λ d	Dominant Wavelength	MIN.	567.5	617.5	nm	IF=20mA
		TYP.	571.0	631.0		
		MAX.	576.5	637.5		
Δλ	Spectral Line Half-Width	TYP.	15	20	nm	IF=20mA
VF	Forward Voltage	MIN.	1.5	1.5	V	IF=20mA
		TYP.	2.0	2.0		
		MAX.	2.5	2.5		
IR	Reverse Current	MAX.	10	10	μ A	VR=5V

Note:

1. θ1/2 is the angle from optical centerline where the luminous intensity is 1/2 optical centerline value

Absolute Maximum Ratings At Ta=25°C

Parameter	Green	Red	Unit
Power Dissipation	75	75	mW
Peak Forward Current[1]	100	100	mA
Continuous Forward Current	30	30	mA
Dreading Linear From30°C	0.4	0.4	mA/°C
Reverse Voltage	5	5	V
Electrostatic Discharge Threshold(HBM)	2000	2000	V
Operating Temperature Range	-45°C to + 85°C		
Storage Temperature Range	-55°C to + 105°C		
Soldering Condition	260°C For 10 Seconds		

Note:

1. 1/10DutyCycle, 0.1msPulseWidth

Electrical Optical Characteristics Curves At Ta=25 °C

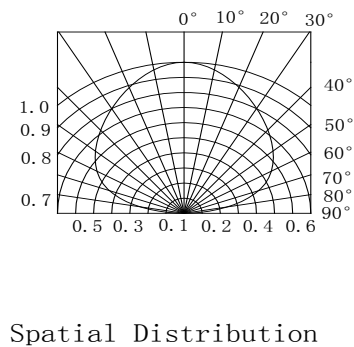
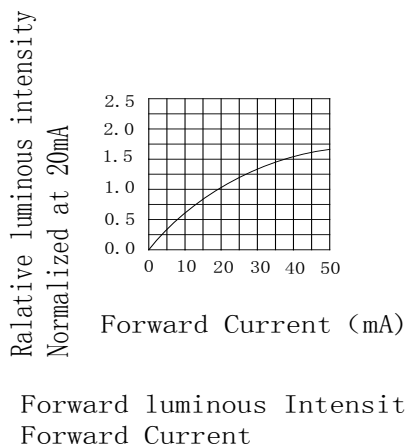
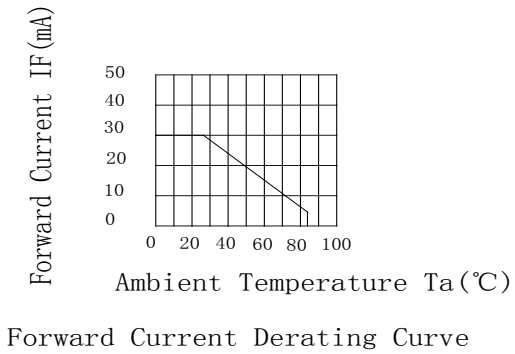
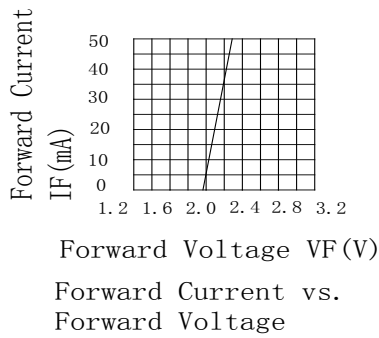
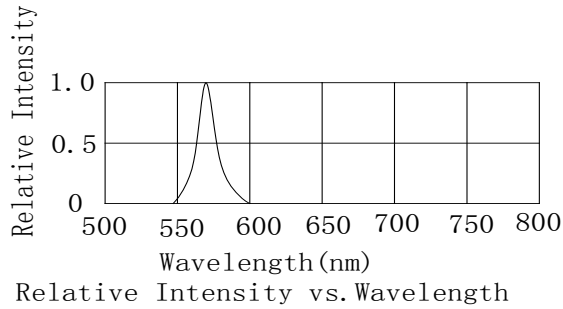

Electrical Optical Characteristics Curves At Ta=25 °C

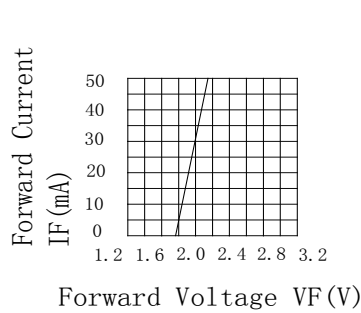
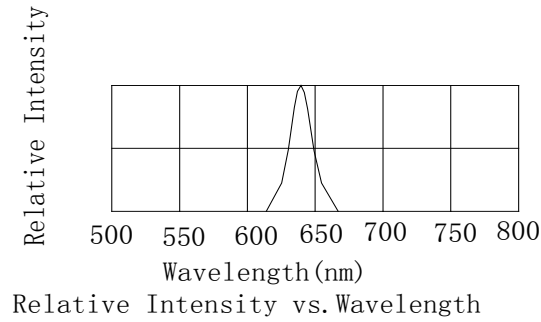

Forward Current vs. Forward Voltage

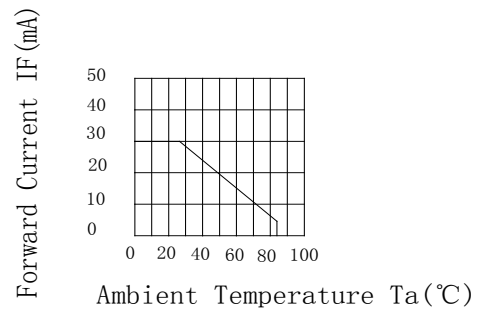

Forward Current Derating Curve

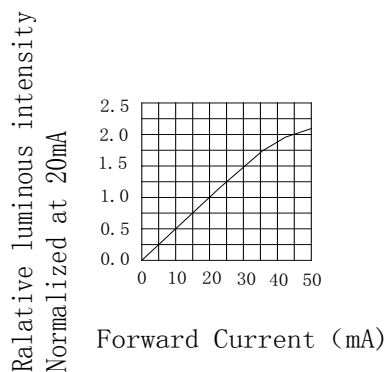

Forward luminous Intensity vs. Forward Current

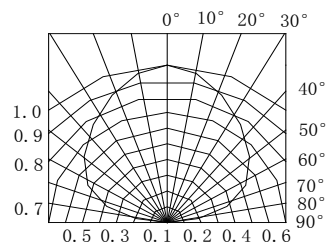

Spatial Distribution

Bin Range Of Luminous Intensity

Symbol	Bin Code	Min.	Max.	Unit	Condition
Iv(G)	M	18	28	mcd	IF=20mA
	N	28	45		
	P	45	71		
	Q	71	112		
Iv(R)	N	28	45	mcd	IF=20mA
	P	45	72		
	Q	72	112		
	R	112	180		
	S	180	280		

Bin Range Of Forward Voltage

Symbol	Bin Code	Min.	Max.	Unit	Condition
VF(G)	V15	1.5	1.7	V	IF=20mA
	V17	1.7	1.9		
	V19	1.9	2.1		
	V21	2.1	2.3		
	V23	2.3	2.5		
VF(R)	V15	1.5	1.7	V	IF=20mA
	V17	1.7	1.9		
	V19	1.9	2.1		
	V21	2.1	2.3		
	V23	2.3	2.5		

Bin Range Of Dominate Wavelength

Symbol	Bin Code	Min.	Max.	Unit	Condition
λ d(G)	G1	567.5	570.5	nm	IF=20mA
	G2	570.5	573.5		
	G3	573.5	576.5		
λ d(R)	R1	617.5	621.5	nm	IF=20mA
	R2	621.5	625.5		
	R3	625.5	629.5		
	R4	629.5	633.5		
	R5	633.5	637.5		

Notes:

1. Tolerance of Luminous Intensity +/-20%
2. Tolerance of Forward Voltage +/-0.15V
3. Tolerance of the Dominate Wavelength +/- 2nm

SMT Reflow Soldering Instructions

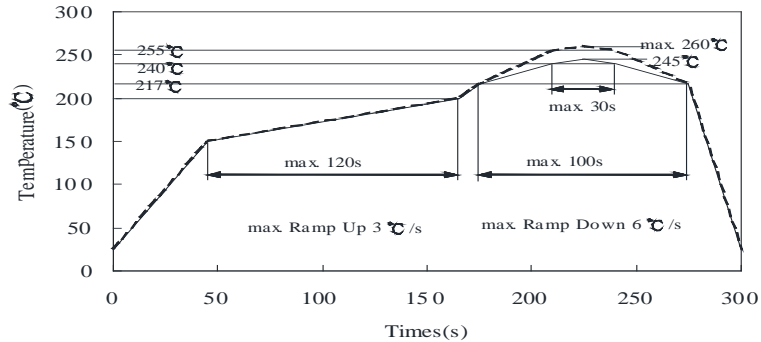

Notes:

1. Selles gives no other assurances regarding the ability of to withstand ESD. It is recommended to use a wrist band or anti-electrostatic glove when handling the LED. All devices, equipment and machinery must be properly grounded.
2. Reflow soldering should not be done more than two times.
3. Do not stress LED when soldering, and do not warp the circuit board after soldering
4. While using Iron, Power dissipation of Iron should be smaller than 25W, and temperature should be controllable. The work should be finished within 2 sec under 320°C for once only.

Application

In order to ensure intensity uniformity on multiple LEDs connected in parallel in an application, it is recommended to use individual resistor separately, as shown in Circuit A below. The brightness of each LED shown in Circuit B might appear difference due to the differences in the I-V characteristics of those LEDs.

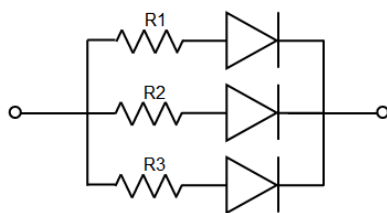

Circuit model A

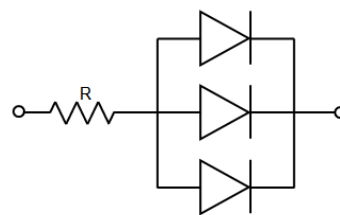

Circuit model B

Reel Dimensions

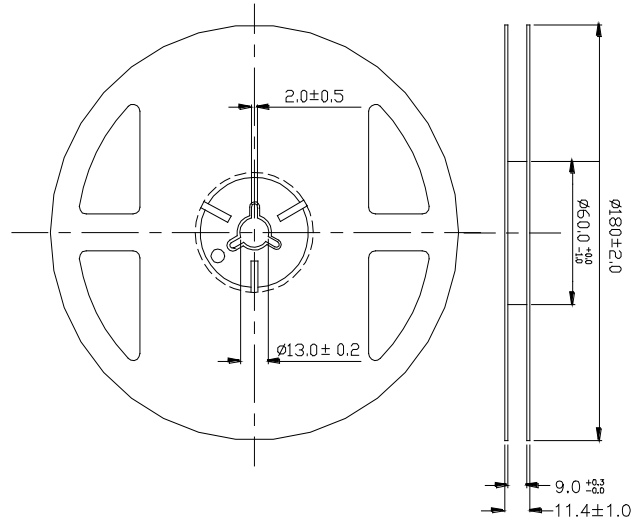

Package Specifications (Units: mm(inches))

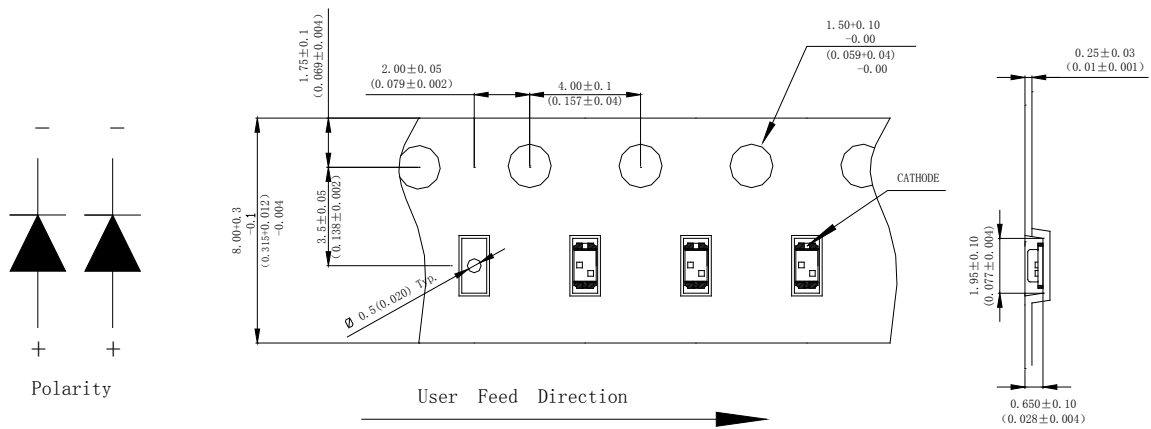

Notes:

1. The LEDs should be used within a year.
2. The LEDs should be kept in 5~30°C and 60% RH for less.
3. The LEDs should be used within 24 hours, or else should be kept a 5~30°C and 30% RH or less. And LEDs should be used within 7 days after opening the package.

Reliability Test Items Conditions

Classification	Test Item	Test Conditions	Test hours	Result
Endurance Test	Operation Life	Connect with a power $I_F=20\text{mA}$ T_a =Under room temperature	1000Hrs	0/20
	High Temperature High Humidity	$T_a=+65^\circ\text{C}\pm 5^\circ\text{C}$ RH=90%-95%	240Hrs	0/20
	High Temperature Storage	High $T_a=+100^\circ\text{C}\pm 5^\circ\text{C}$	1000Hrs	0/20
	Low Temperature Storage	Low $T_a=-50^\circ\text{C}\pm 5^\circ\text{C}$ Test time=1000hrs	1000Hrs	0/20
Environmental Test	Temperature Cycling	$-50^\circ\text{C}\sim+105^\circ\text{C}$ 15min 5min 15min	300 Cycles	0/20
	Thermal Shock	$-45^\circ\text{C}\sim\pm 5^\circ\text{C}\sim+85^\circ\text{C}\sim\pm 5^\circ\text{C}$ 5min 10sec 5min	300 Cycles	0/20
	Solder Resistance	Preheating: $120^\circ\text{C}-150^\circ\text{C}$, within 2 minutes. Operation heating : 260°C (Max.), within 10 seconds(Max.)	5Cycles	0/20

Judgment criteria of failure for the reliability

Measuring items	Symbol	Measuring conditions	Judgment criteria for failure
Forward voltage	$V_F(\text{V})$	$I_F=20\text{mA}$	Over $U\times 1.2$
Reverse current	$I_R(\mu\text{A})$	$V_R=5\text{V}$	Over $U\times 2$
Luminous intensity	$I_v(\text{mcd})$	$I_F=20\text{mA}$	Below $S\times 0.5$

Note: 1.U means the upper limit of specified characteristics. S means initial value.

2.Measurment shall be taken between 2 hours after the test pieces have been returned to normal ambient conditions after completion of each test.

Moisture Resistant Packaging

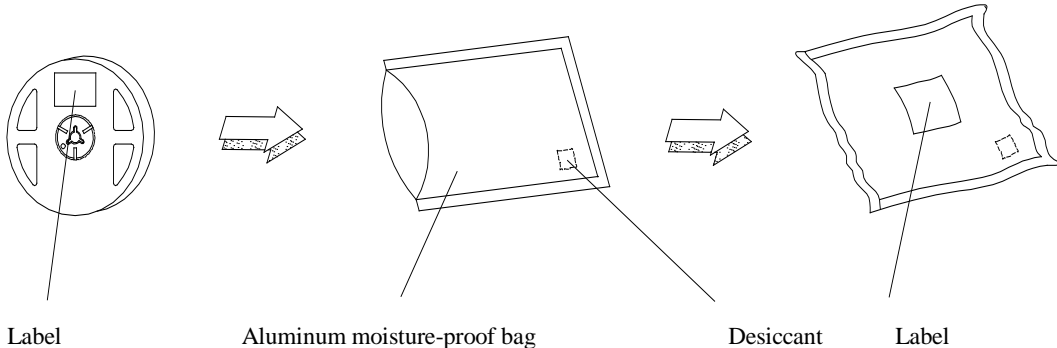

Remark: Add Desiccant into Aluminum moisture-proof bag

Label Explanation

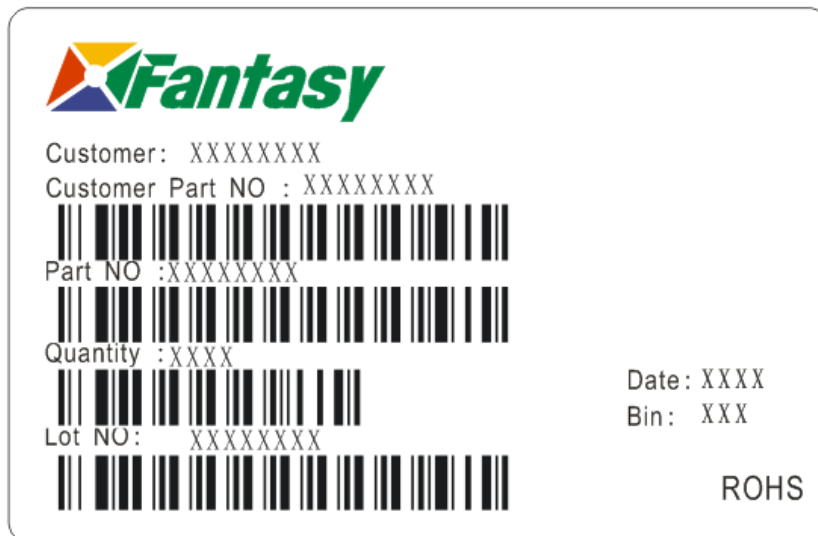

Customer: Customer Name
 Customer Part NO: Customer's Product Number
 Part NO : Fantasy Product Number
 Quantity : Packing Quantity
 Lot NO : Lot Number
 Date : Product Date (Week)
 Bin: Rank of Luminous Intensity ,Dom. Wavelength, Forward Voltage