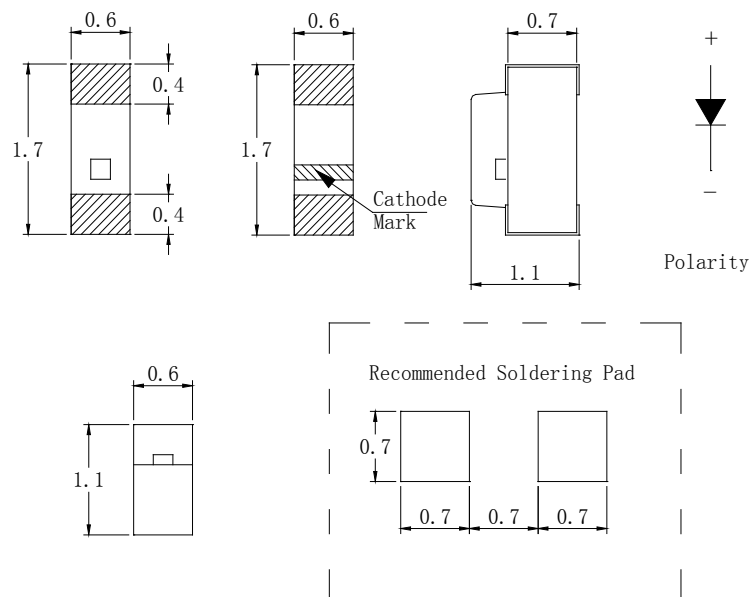

Features

- 1.70mm*1.10mm SMT LED, Super thin (0.60H mm)
- Low Power Consumption
- Wide Viewing Angle
- Various Colors
- Compatible with automatic placement equipment.
- Compatible with infrared and vapor phase reflow and wave solder process.
- Meet ROHS Green Product
- Package: 3000pcs/Reel

Applications

- Backlight and Indicator

Package Dimensions**Notes:**

1. All dimensions are in millimeters (inches).
2. Tolerance is $\pm 0.2\text{mm}$ (.0079") unless otherwise noted.
3. Specifications are subject to change without notice
4. This drawing is only for reference, not as a basis for the actual structure.

www.FantasyLeds.com

Sales@FantasyLeds.com



Selection Guide

Part No	Lens Type	Dice	Emitted Color
FSL-1711060B-FASNC3	Water clear	InGaN	Blue

Electrical / Optical Characteristics At Ta=25 °C

Parameter	Symbol	MIN.	TYP.	MAX.	Unit	Test Condition
Iv	Luminous Intensity	28	112	-	mcd	IF=20mA
2θ1/2	Viewing Angle	-	130	-	deg	IF=20mA
λ Peak	Peak Emission Wavelength	-	468	-	nm	IF=20mA
λ d	Dominant Wavelength	460	470	475	nm	IF=20mA
Δλ	Spectral Line Half-Width	-	25	-	nm	IF=20mA
VF	Forward Voltage	2.5	3.0	3.9	V	IF=20mA
IR	Reverse Current	-	-	10	μ A	VR=5V

Note:

1. θ1/2 is the angle from optical centerline where the luminous intensity is 1/2 optical centerline value

Absolute Maximum Ratings At Ta=25°C

Parameter	Blue	Unit
Power Dissipation	120	mW
Peak Forward Current[1]	100	mA
Continuous Forward Current	30	mA
Derating Linear From 25°C	0.25	mA/°C
Reverse Voltage	5	V
Electrostatic Discharge Threshold (HBM)	400	V
Operating Temperature Range	-45°C to + 85°C	
Storage Temperature Range	-55°C to + 105°C	
Soldering Condition	260°C For 10 Seconds	

Note:

1. 1/10DutyCycle,0.1msPulseWidth

Electrical Optical Characteristics Curves At Ta=25°C

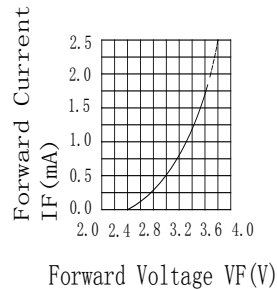
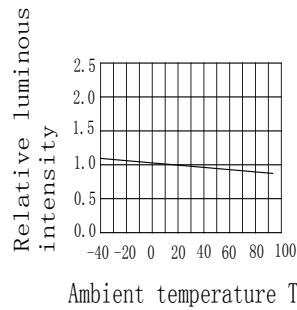
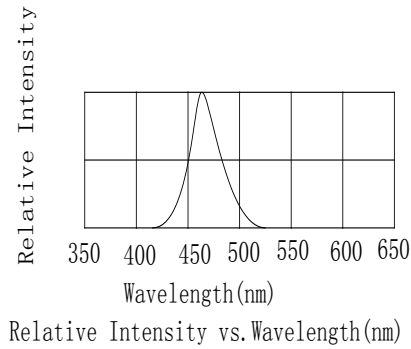

Relative Luminous Intensity vs. Ambient temperature

Forward Current vs. Forward Voltage

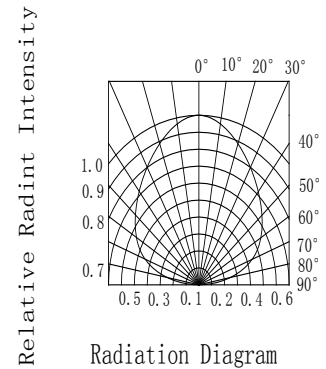
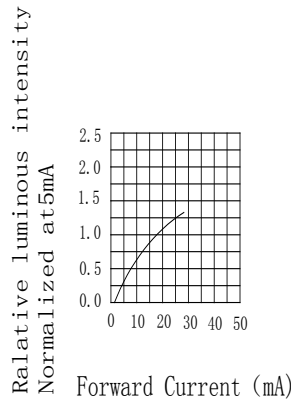
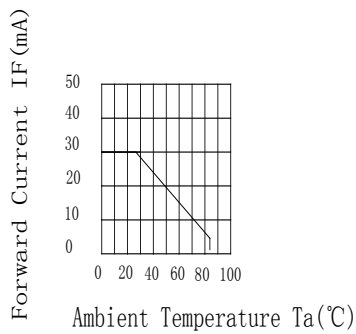

Forward Current Derating Curve

Forward Intensity vs. Forward Current

Radiation Diagram

Bin Range Of Luminous Intensity

Symbol	Bin Code	Min.	Max.	Unit	Condition
Iv	N	28	45	mcd	IF=20mA
	P	45	72		
	Q	72	112		
	R	112	180		
	S	180	280		

Bin Range Of Forward Voltage

Symbol	Bin Code	Min.	Max.	Unit	Condition
VF	V25	2.50	2.70	V	IF=20mA
	V27	2.70	2.90		
	V29	2.90	3.10		
	V31	3.10	3.30		
	V33	3.30	3.50		
	V35	3.50	3.70		
	V37	3.70	3.90		

Bin Range Of Dominate Wavelength

Symbol	Bin Code	Min.	Max.	Unit	Condition
λ d	B1	460	465	nm	IF=20mA
	B2	465	470		
	B3	470	475		

Notes:

1. Tolerance of Luminous Intensity +/-20%
2. Tolerance of Forward Voltage +/-0.15V
3. Tolerance of the Dominate Wavelength +/- 2nm

SMT Reflow Soldering Instructions

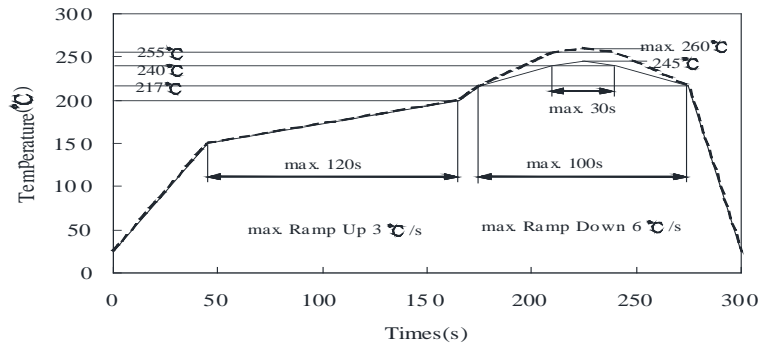

Notes:

1. Selles gives no other assurances regarding the ability of to withstand ESD. It is recommended to use a wrist band or anti-electrostatic glove when handling the LED. All devices, equipment and machinery must be properly grounded.
2. Reflow soldering should not be done more than two times.
3. Do not stress LED when soldering, and do not warp the circuit board after soldering
4. While using Iron, Power dissipation of Iron should be smaller than 25W, and temperature should be controllable. The work should be finished within 2 sec under 320°C for once only.

Application

In order to ensure intensity uniformity on multiple LEDs connected in parallel in an application, it is recommended to use individual resistor separately, as shown in Circuit A below. The brightness of each LED shown in Circuit B might appear difference due to the differences in the I-V characteristics of those LEDs.

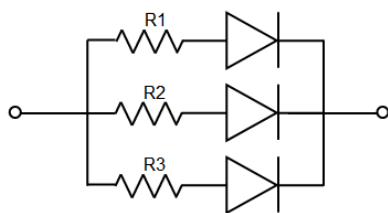

Circuit model A

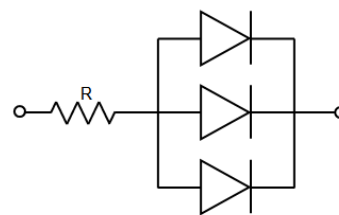

Circuit model B

Reel Dimensions

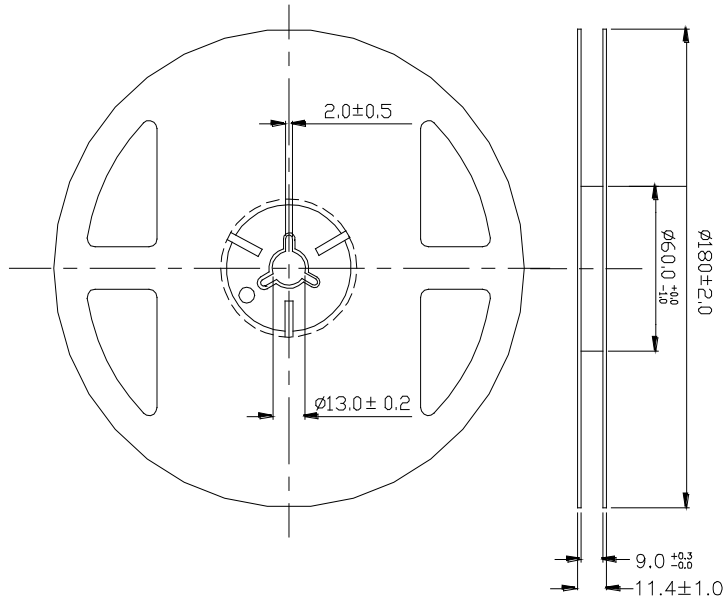

Package Specifications (Units: mm(inches))

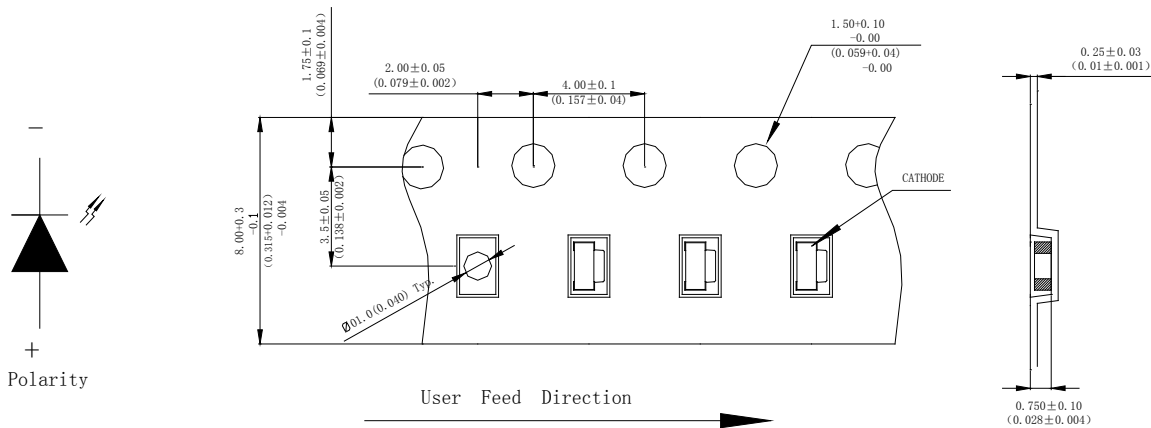

Notes:

1. The LEDs should be used within a year.
2. The LEDs should be kept in 5~30°C and 60% RH for less.
3. The LEDs should be used within 24 hours, or else should be kept a 5~30°C and 30% RH or less. And LEDs should be used within 7 days after opening the package.

Reliability Test Items Conditions

Classification	Test Item	Test Conditions	Test hours	Result
Endurance Test	Operation Life	Connect with a power $I_F=20\text{mA}$ T_a =Under room temperature	1000Hrs	0/20
	High Temperature High Humidity	$T_a=+65^\circ\text{C}\pm 5^\circ\text{C}$ RH=90%-95%	240Hrs	0/20
	High Temperature Storage	High $T_a=+100^\circ\text{C}\pm 5^\circ\text{C}$	1000Hrs	0/20
	Low Temperature Storage	Low $T_a=-50^\circ\text{C}\pm 5^\circ\text{C}$ Test time=1000hrs	1000Hrs	0/20
Environmental Test	Temperature Cycling	$-50^\circ\text{C}\sim+105^\circ\text{C}$ 15min 5min 15min	300 Cycles	0/20
	Thermal Shock	$-45^\circ\text{C}\sim\pm 5^\circ\text{C}\sim+85^\circ\text{C}\sim\pm 5^\circ\text{C}$ 5min 10sec 5min	300 Cycles	0/20
	Solder Resistance	Preheating: $120^\circ\text{C}-150^\circ\text{C}$, within 2 minutes. Operation heating : 260°C (Max.), within 10 seconds(Max.)	5Cycles	0/20

Judgment criteria of failure for the reliability

Measuring items	Symbol	Measuring conditions	Judgment criteria for failure
Forward voltage	$V_F(\text{V})$	$I_F=20\text{mA}$	Over $U\times 1.2$
Reverse current	$I_R(\mu\text{A})$	$V_R=5\text{V}$	Over $U\times 2$
Luminous intensity	$I_v(\text{mcd})$	$I_F=20\text{mA}$	Below $S\times 0.5$

Note: 1.U means the upper limit of specified characteristics. S means initial value.

2.Measurment shall be taken between 2 hours after the test pieces have been returned to normal ambient conditions after completion of each test.

Moisture Resistant Packaging

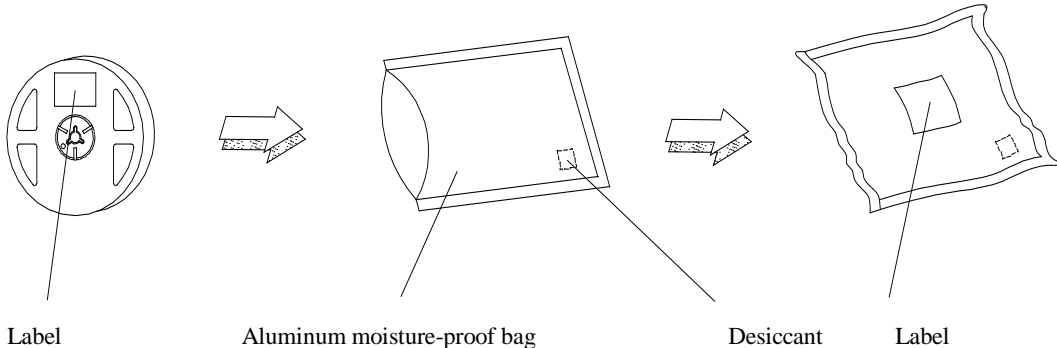

Remark: Add Desiccant into Aluminum moisture-proof bag

Label Explanation

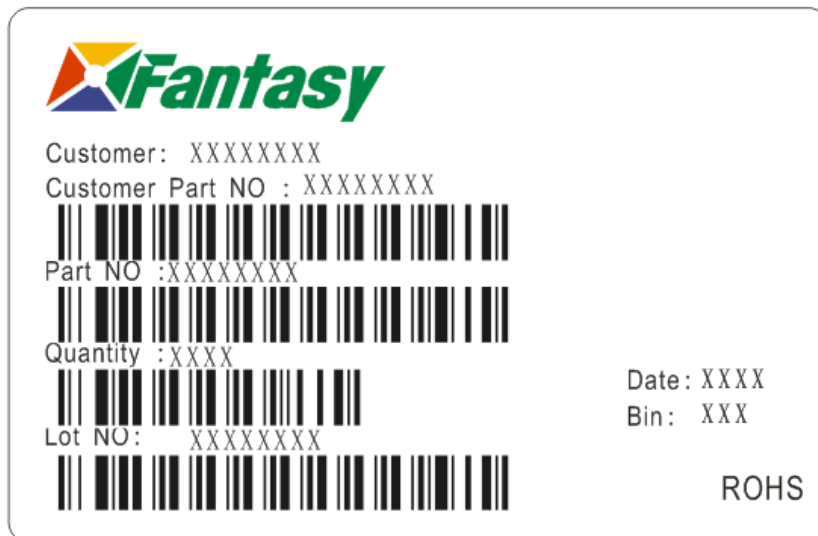

Customer: Customer Name
 Customer Part NO: Customer's Product Number
 Part NO : Fantasy Product Number
 Quantity : Packing Quantity
 Lot NO : Lot Number
 Date : Product Date (Week)
 Bin: Rank of Luminous Intensity ,Dom. Wavelength, Forward Voltage