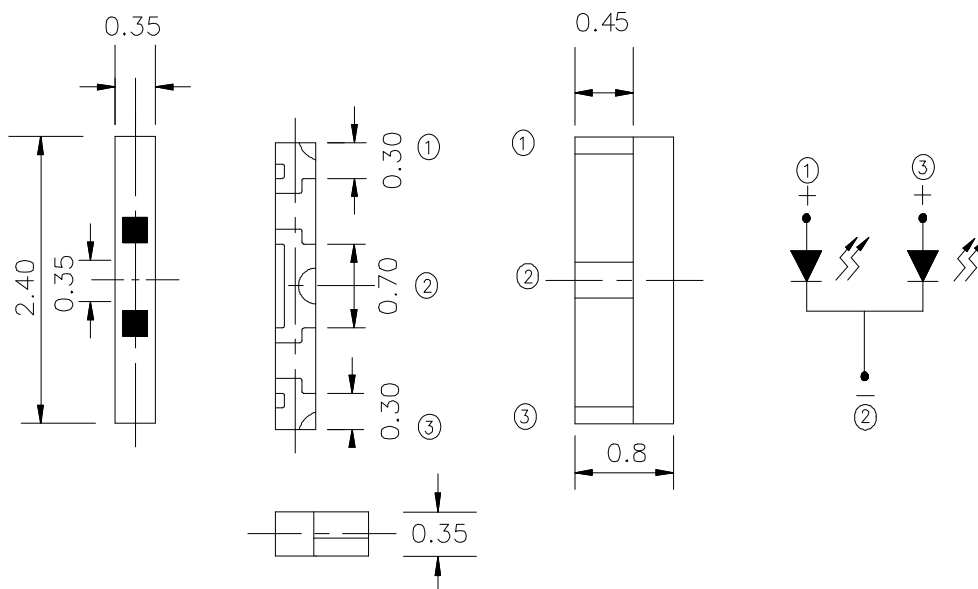

Features

- Package in 12mm tape on 7" diameter reels.
- Compatible with automatic placement equipment.
- Compatible with infrared and vapor phase reflow solder process.
- I.C. compatible
- Meet green product and Pb-free(According to RoHS)

Applications

- Backlight and Indicator

Package Dimensions**Notes:**

1. All dimensions are in millimeters (inches).
2. Tolerance is $\pm 0.2\text{mm}(.0079")$ unless otherwise noted.
3. Specifications are subject to change without notice
4. This drawing is only for indication, not as a basis for the actual structure.



Selection Guide

| Part No | Lens Type | Dice | Emitted Color |
|---------------------------|-----------|------------------|---------------|
| FSL-2408035WR-LNSCNTCH-CC | Yellow | InGaN AlInGaP | White Red |

Electrical / Optical Characteristics At Ta=25°C

| Symbol | Parameter | | Red | White | Unit | Test Condition |
|-----------|--------------------------|------|-----|-------|------|----------------|
| Iv | Luminous Intensity | MIN. | 200 | 450 | mcd | If=20mA |
| | | TYP. | 450 | 900 | | |
| | | MAX. | 560 | 1120 | | |
| 2θ1/2 | Viewing Angle | TYP. | 130 | 130 | deg | If=20mA |
| λ Peak(x) | Peak Emission Wavelength | TYP. | 639 | 0.30 | nm | If=20mA |
| λ d(y) | Dominant Wavelength | TYP. | 631 | 0.30 | nm | If=20mA |
| Δλ | Spectral Line Half-Width | TYP. | 17 | 20 | nm | If=20mA |
| VF | Forward Voltage | MIN. | 1.8 | 2.85 | V | If=20mA |
| | | TYP. | 2.0 | 3.10 | | |
| | | MAX. | 2.4 | 3.65 | | |

Note:

1. The Luminous Intensity is measured with the led excluded the black lens cover.
2. The chromaticity coordinates(x,y) is derived form 1931 CIE chromaticity diagram.
3. The chromaticity coordinates(x,y) guarantee should be added±0.02 tolerance.

Absolute Maximum Ratings At Ta=25°C

| Parameter | Red | White | Unit |
|--|---------------------|-------|-------|
| Power Dissipation | 75 | 95 | mW |
| Peak Forward Current[1] | 80 | 100 | mA |
| Continuous Forward Current | 25 | 25 | mA |
| Derating Linear From 25°C | 0.4 | 0.25 | mA/°C |
| Reverse Voltage | 5 | 5 | V |
| Electrostatic Discharge Threshold(HBM) | 2000 | 150 | V |
| Operating Temperature Range | -55°C to + 85°C | | |
| Storage Temperature Range | -55°C to + 85°C | | |
| Soldering Condition | 260°C For 5 Seconds | | |

Note:

1. 1/10DutyCycle,0.1msPulseWidth

Electrical Optical Characteristics Curves At Ta=25°C

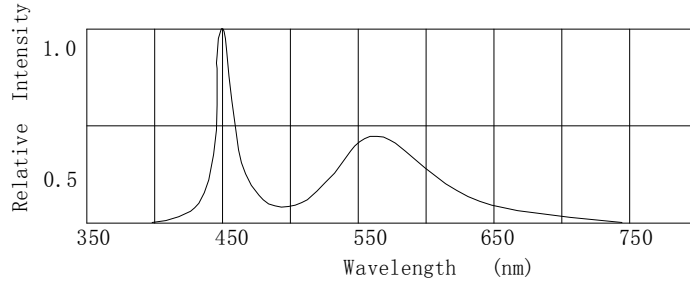

Fig.1 Relative Intensity VS. Wavelength

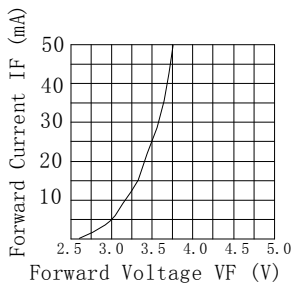

Fig.2 Forward Current vs. Forward Voltage

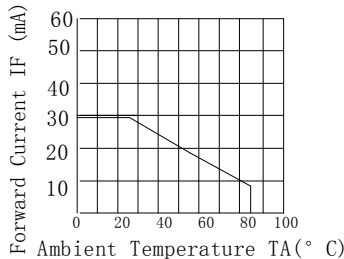

Fig.3 Forward Current Derating Curve

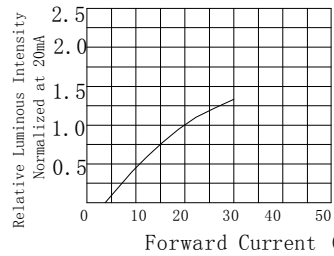

Fig.4 Relative Luminous Intensity vs. Forward Current

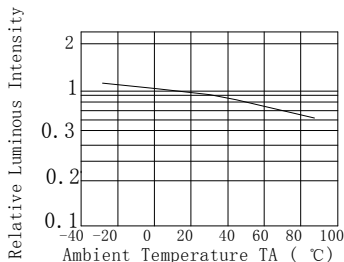

Fig.5 Luminous Intensity vs. Ambient Temperature

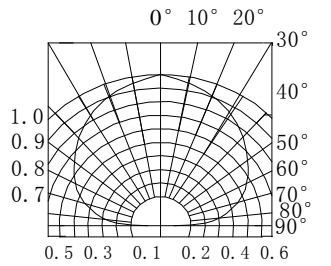

Fig.6 Spatial Distribution

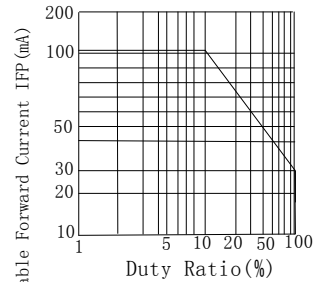

Fig.7 Duty Ratio vs. Allowable Forward Current

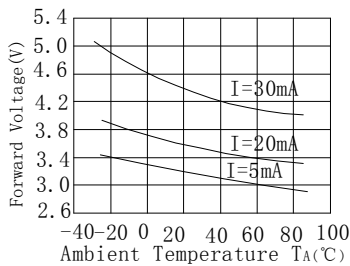

Fig.8 Ambient Temperature vs. Forward Voltage

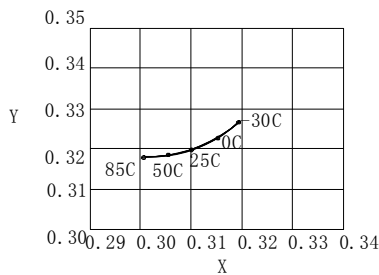

Fig.9 Ambient Temperature TA (°C) Chromaticity Coordinate

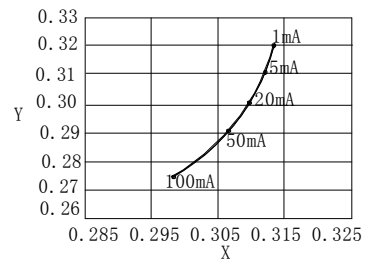

Fig.10 Forward Current VS. Chromaticity Coordinate

Electrical Optical Characteristics Curves At Ta=25°C

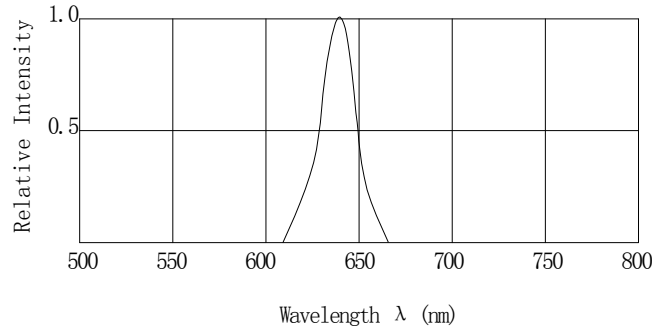

Fig. 1 Relative Intensity vs. Wavelength

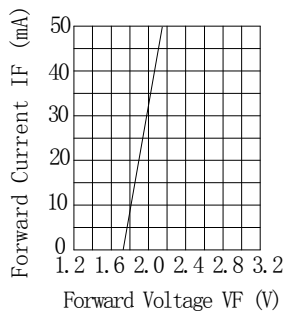

Fig. 2 Forward Current VS. Forward Voltage

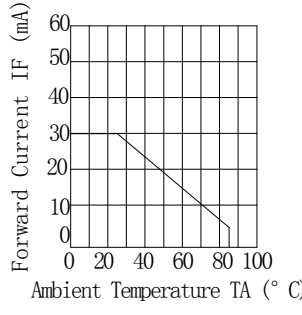

Fig. 3 Forward Current Derating Curve

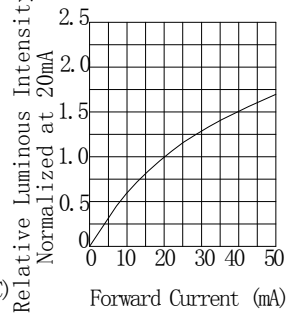

Fig. 4 Relative Luminous Intensity VS. Forward Current

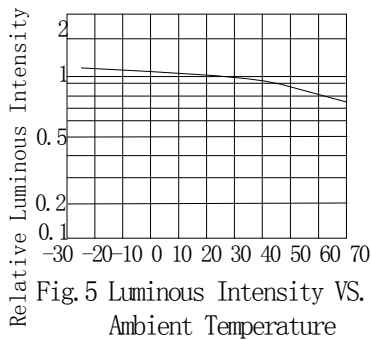

Fig. 5 Luminous Intensity VS. Ambient Temperature

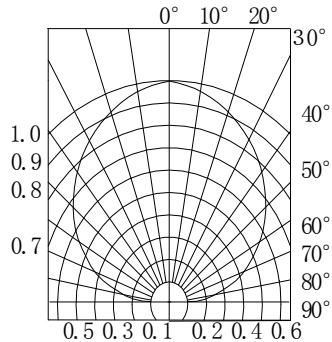

Fig. 6 Spatial Distribution



Bin Range Of Luminous Intensity (+/-20%)

| Symbol | Bin Code | Min. | Max. | Unit | Condition |
|------------|----------|------|------|------|-----------|
| Iv (White) | U1 | 450 | 570 | mcd | IF=20mA |
| | U2 | 570 | 720 | | |
| | V1 | 720 | 900 | | |
| | V2 | 900 | 1120 | | |

| Symbol | Bin Code | Min. | Max. | Unit | Condition |
|----------|----------|------|------|------|-----------|
| Iv (Red) | S | 200 | 450 | mcd | IF=20mA |
| | T | 450 | 570 | | |

Bin Range Of Forward Voltage (+/-0.15)

| Symbol | Bin Code | Min. | Max. | Unit | Condition |
|------------|----------|------|------|------|-----------|
| VF (White) | V2 | 2.85 | 3.25 | V | IF=20mA |
| | V6 | 3.25 | 3.65 | | |

| Symbol | Bin Code | Min. | Max. | Unit | Condition |
|----------|----------|------|------|------|-----------|
| VF (Red) | VR | 1.8 | 2.4 | V | IF=20mA |

Chromaticity Coordinates Specifications for Bin Grading (+/-0.02)

IF=20mA

| BIN | X | Y | X | Y | X | Y | X | Y |
|-----|-------|-------|-------|-------|-------|-------|-------|-------|
| B1 | 0.254 | 0.198 | 0.254 | 0.23 | 0.274 | 0.258 | 0.254 | 0.198 |
| B2 | 0.254 | 0.23 | 0.254 | 0.263 | 0.274 | 0.291 | 0.274 | 0.258 |
| B3 | 0.234 | 0.17 | 0.234 | 0.202 | 0.254 | 0.23 | 0.254 | 0.198 |
| B4 | 0.234 | 0.202 | 0.234 | 0.235 | 0.254 | 0.263 | 0.254 | 0.23 |
| S1 | 0.274 | 0.226 | 0.274 | 0.258 | 0.294 | 0.286 | 0.294 | 0.254 |
| S2 | 0.274 | 0.258 | 0.274 | 0.291 | 0.294 | 0.319 | 0.294 | 0.286 |
| S3 | 0.294 | 0.254 | 0.294 | 0.286 | 0.314 | 0.315 | 0.314 | 0.282 |
| S4 | 0.294 | 0.286 | 0.294 | 0.319 | 0.314 | 0.347 | 0.314 | 0.315 |
| S5 | 0.314 | 0.282 | 0.314 | 0.315 | 0.334 | 0.343 | 0.334 | 0.311 |
| S6 | 0.314 | 0.315 | 0.314 | 0.347 | 0.334 | 0.376 | 0.334 | 0.343 |

CIE Chromaticity Diagram (+/-0.02)

IF=20mA

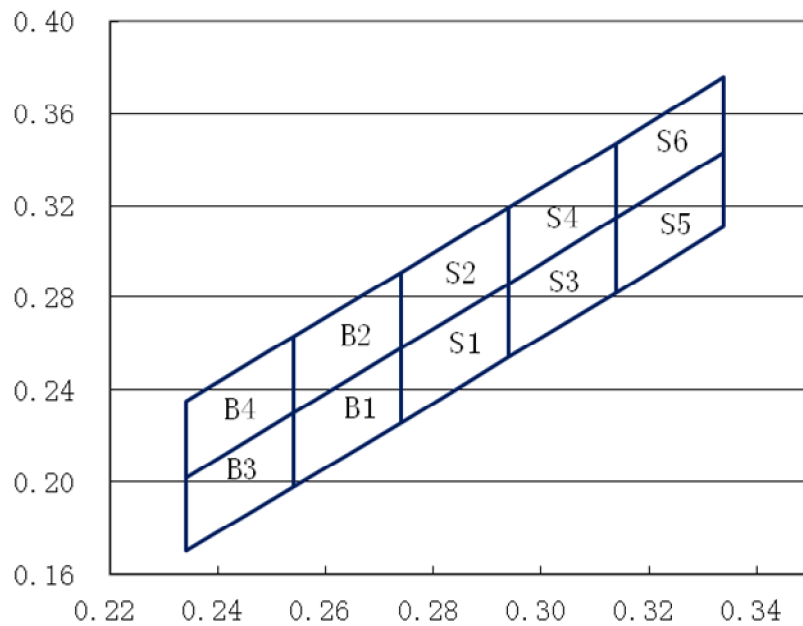

SMT Reflow Soldering Instructions

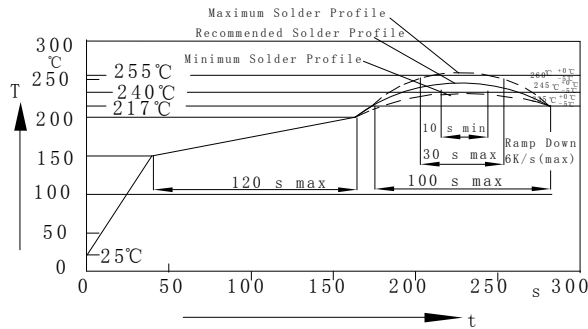

Notes:

- Selles gives no other assurances regarding the ability of to withstand ESD. It is recommended to use a wrist band or anti-electrostatic glove when handling the LED. All devices, equipment and machinery must be properly grounded.
- Reflow soldering should not be done more than two times.
- Do not stress LED when soldering, and do not warp the circuit board after soldering
- While using Iron, Power dissipation of Iron should be smaller than 25W, and temperature should be controllable. The work should be finished within 2 sec under 320°C for once only.

Recommended Soldering Pad Dimensions

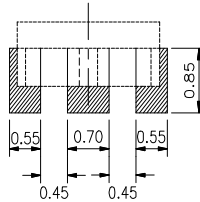

Package Specifications (Units: mm(inches))

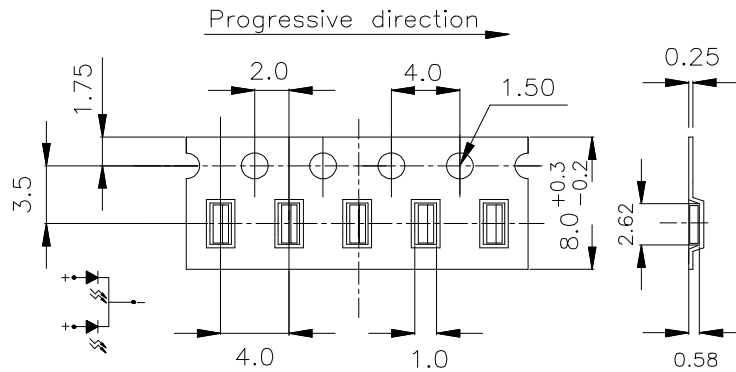

Notes:

- The LEDs should be used within a year.
- The LEDs should be kept in 5~30°C and 60% RH for less.
- The LEDs should be used within 24 hours, or else should be kept a 5~30°C and 30% RH or less. And LEDs should be used within 7 days after opening the package.

Reliability Test Items Conditions

| Classification | Test Item | Test Conditions | Test hours | Result |
|--------------------|-----------------------------------|---|------------|--------|
| Endurance Test | Operation Life | Connect with a power $I_F=20mA$ T_a =Under room temperature | 1000Hrs | 0/20 |
| | High Temperature High Humidity | $T_a=+65^{\circ}C \pm 5^{\circ}C$ RH=90%-95% | 240Hrs | 0/20 |
| | High Temperature Storage | High $T_a=+85^{\circ}C \pm 5^{\circ}C$ | 1000Hrs | 0/20 |
| | Low Temperature Storage | Low $T_a=-35^{\circ}C \pm 5^{\circ}C$ Test time=1000hrs | 1000Hrs | 0/20 |
| Environmental Test | Temperature Cycling | $-45^{\circ}C \sim +105^{\circ}C$ 15min 5min 15min | 300 Cycles | 0/20 |
| | Thermal Shock | $-35^{\circ}C \sim \pm 5^{\circ}C \sim +85^{\circ}C \sim \pm 5^{\circ}C$ 5min 10sec 5min | 300 Cycles | 0/20 |
| | Solder Resistance | Preheating: $120^{\circ}C - 150^{\circ}C$, within 2 minutes. Operation heating : $260^{\circ}C$ (Max.), within 5 seconds (Max.) | 5Cycles | 0/20 |

Judgment criteria of failure for the reliability

| Measuring items | Symbol | Measuring conditions | Judgment criteria for failure |
|--------------------|------------|----------------------|-------------------------------|
| Forward voltage | $V_F(V)$ | $I_F=20mA$ | Over $U \times 1.2$ |
| Luminous intensity | $I_v(mcd)$ | $I_F=20mA$ | Below $S \times 0.5$ |

Note: 1.U means the upper limit of specified characteristics. S means initial value.

2.Measurment shall be taken between 2 hours after the test pieces have been returned to normal ambient conditions after completion of each test.