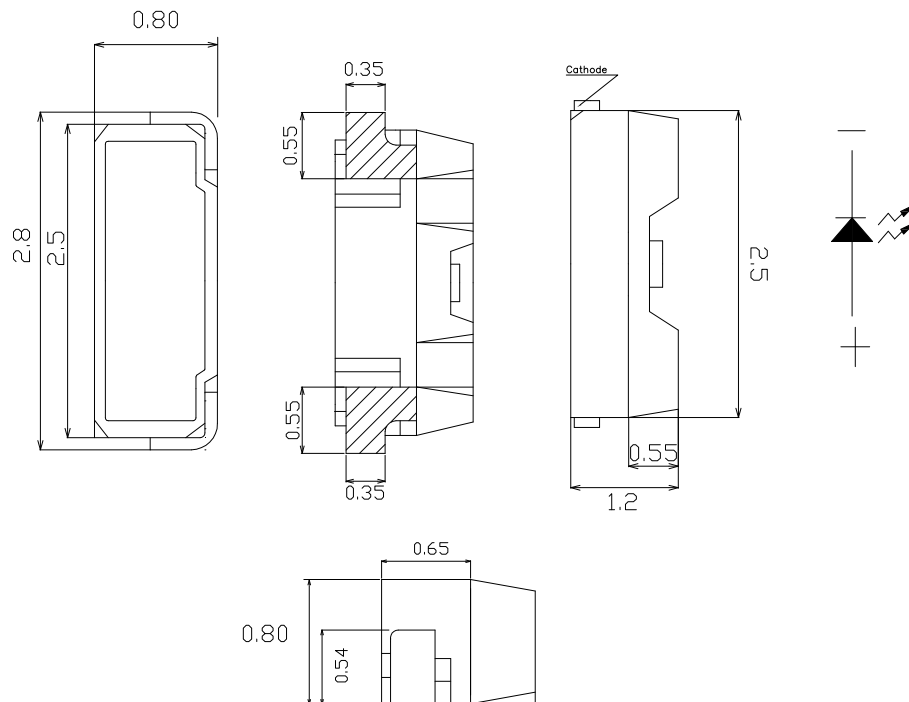

Features

- Package in 12mm tape on 7" diameter reels.
- Compatible with automatic placement equipment.
- Compatible with infrared and vapor phase reflow solder process.
- I.C. compatible
- Meet green product and Pb-free(According to RoHS)
- Package : 2000pcs/Reel

Applications

- Backlight and Indicator

Package Dimensions**Notes:**

1. All dimensions are in millimeters (inches).
2. Tolerance is $\pm 0.2\text{mm}$ (.0079") unless otherwise noted.
3. Specifications are subject to change without notice
4. This drawing is only for indication, not as a basis for the actual structure.



Selection Guide

Part No	Lens Type	Dice	Emitted Color
FSL-2812080R-SCQ1T2SPR	Water Clear	AllInGap	Red

Electrical / Optical Characteristics At Ta=25°C

Parameter	Symbol	Min.	Typ.	Max.	Unit	Test Condition
Iv	Luminous Intensity	72	280	450	mcd	IF=20mA
2θ1/2	Viewing Angle		110		deg	
λ Peak	Peak Emission Wavelength		631		nm	IF=20mA
λ d	Dominant Wavelength	617.5	625.5	633.5	nm	IF=20mA
Δλ	Spectral Line Half-Width		20		nm	IF=20mA
VF	Forward Voltage	1.7	2.0	2.5	V	IF=20mA
IR	Reverse Current			100	uA	VR=5V

Note:

1. θ1/2 is the angle from optical centerline where the luminous intensity is 1/2 optical centerline value
2. The chromaticity coordinates(x,y) is derived form 1931 CIE chromaticity diagram.

Absolute Maximum Ratings At Ta=25°C

Parameter	Red	Unit
Power Dissipation	75	mW
Peak Forward Current (1/10 Duty Cycle @ 0.1ms)	60	mA
Continuous Forward Current	25	mA
Reverse Voltage	5	V
Electrostatic Discharge Threshold(HBM)	2000	V
Operating Temperature Range	-30°C to + 85°C	
Storage Temperature Range	-40°C to + 100°C	
Soldering Condition	260°C For 10 Seconds	

Electrical Optical Characteristics Curves At Ta=25°C

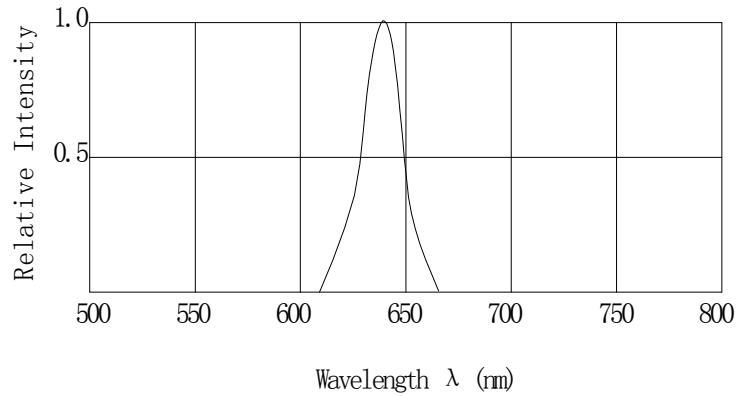

Fig. 1 Relative Intensity vs. Wavelength

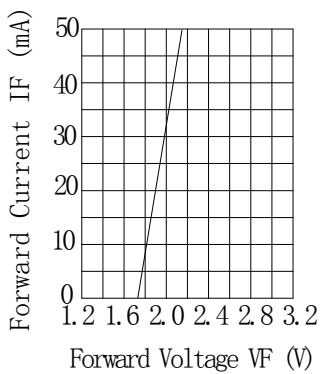

Fig. 2 Forward Current VS. Forward Voltage

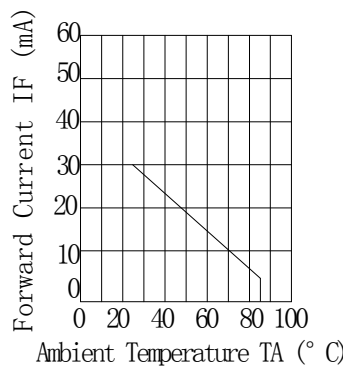

Fig. 3 Forward Current Derating Curve

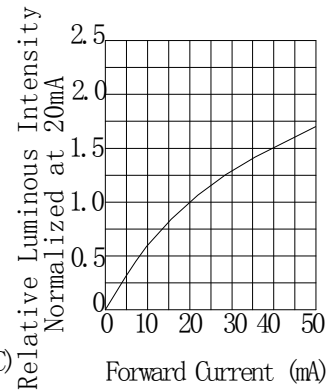

Fig. 4 Relative Luminous Intensity VS. Forward Current

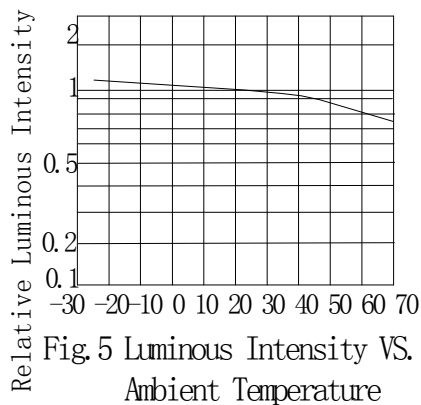

Fig. 5 Luminous Intensity VS. Ambient Temperature

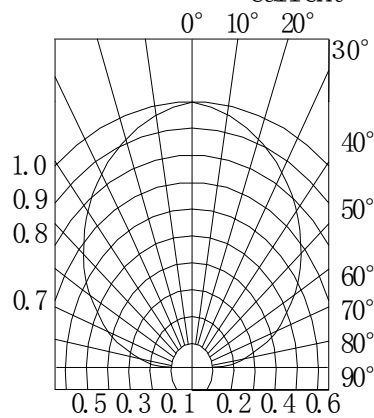

Fig. 6 Spatial Distribution

Bin Range Of Luminous Intensity

Symbol	Bin Code	Min.	Max.	Unit	Condition
Iv	Q	72	112	mcd	IF=20mA
	R	112	180		
	S	180	280		
	T	280	450		

Bin Range Of Forward Voltage

Symbol	Bin Code	Min.	Max.	Unit	Condition
VF	V2	1.7	1.9	V	IF=20mA
	V3	1.9	2.1		
	V4	2.1	2.3		
	V5	2.3	2.5		

Notes:

1. Tolerance of Luminous Intensity +/-20%
2. Tolerance of Forward Voltage +/-0.2V
3. Tolerance of the Dominate Wavelength +/- 2nm

SMT Reflow Soldering Instructions

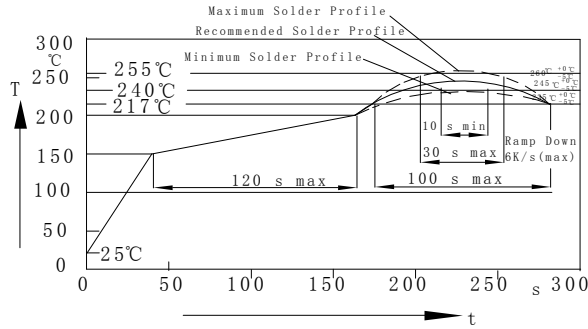

Notes:

1. Selles gives no other assurances regarding the ability of to withstand ESD. It is recommended to use a wrist band or anti-electrostatic glove when handling the LED. All devices, equipment and machinery must be properly grounded.
2. Reflow soldering should not be done more than two times.
3. Do not stress LED when soldering, and do not warp the circuit board after soldering
4. While using Iron, Power dissipation of Iron should be smaller than 25W, and temperature should be controllable. The work should be finished within 2 sec under 320°C for once only.

Recommended Soldering Pad Dimensions

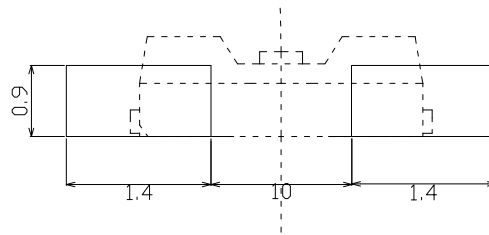

Package Specifications (Units: mm(inches))

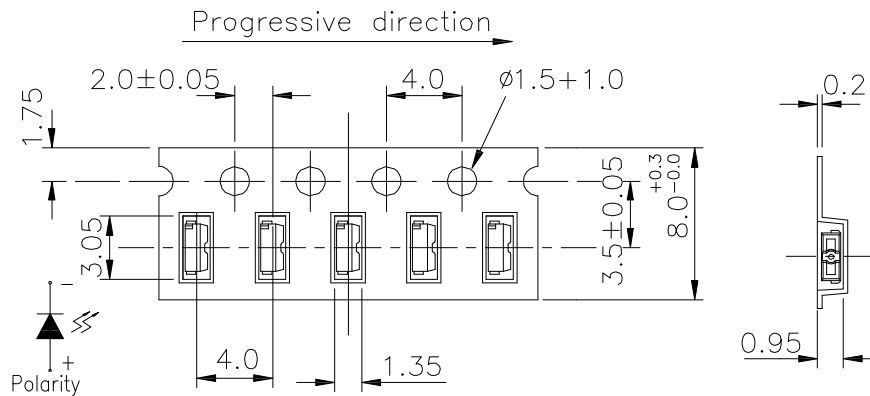

Notes:

1. The LEDs should be used within a year.
2. The LEDs should be kept in 5~30°C and 60% RH for less.
3. The LEDs should be used within 24 hours, or else should be kept a 5~30°C and 30% RH or less. And LEDs should be used within 7 days after opening the package.

Reliability Test Items Conditions

Classification	Test Item	Test Conditions	Test hours	Result
Endurance Test	Operation Life	Connect with a power $I_F=20mA$ T_a =Under room temperature	1000Hrs	0/20
	High Temperature High Humidity	$T_a=+65^{\circ}C \pm 5^{\circ}C$ RH=90%-95%	240Hrs	0/20
	High Temperature Storage	High $T_a=+85^{\circ}C \pm 5^{\circ}C$	1000Hrs	0/20
	Low Temperature Storage	Low $T_a=-35^{\circ}C \pm 5^{\circ}C$ Test time=1000hrs	1000Hrs	0/20
Environmental Test	Temperature Cycling	$-45^{\circ}C \sim +105^{\circ}C$ 15min 5min 15min	300 Cycles	0/20
	Thermal Shock	$-35^{\circ}C \sim \pm 5^{\circ}C \sim +85^{\circ}C \sim \pm 5^{\circ}C$ 5min 10sec 5min	300 Cycles	0/20
	Solder Resistance	Preheating: $120^{\circ}C - 150^{\circ}C$, within 2 minutes. Operation heating : $260^{\circ}C$ (Max.), within 5 seconds (Max.)	5Cycles	0/20

Judgment criteria of failure for the reliability

Measuring items	Symbol	Measuring conditions	Judgment criteria for failure
Forward voltage	$V_F(V)$	$I_F=20mA$	Over $U \times 1.2$
Reverse current	$I_R(\mu A)$	$V_R=5V$	Over $U \times 2$
Luminous intensity	$I_v(mcd)$	$I_F=20mA$	Below $S \times 0.5$

Note: 1.U means the upper limit of specified characteristics. S means initial value.

2.Measurment shall be taken between 2 hours after the test pieces have been returned to normal ambient conditions after completion of each test.