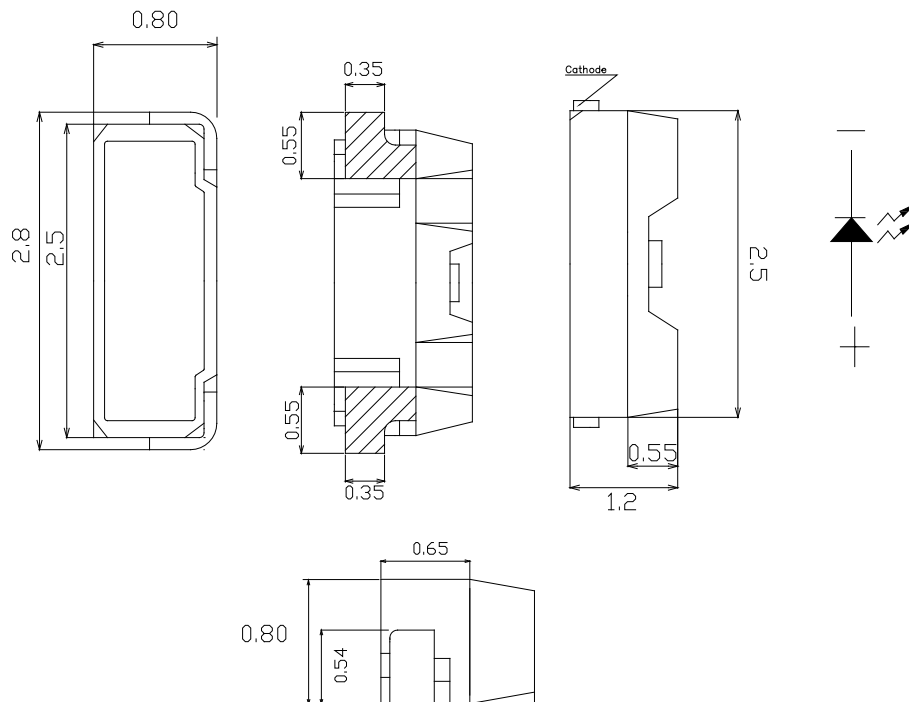

Features

- Package in 12mm tape on 7" diameter reels.
- Compatible with automatic placement equipment.
- Compatible with infrared and vapor phase reflow solder process.
- I.C. compatible
- Meet green product and Pb-free(According to RoHS)
- Package : 2000pcs/Reel

Applications

- Backlight and Indicator

Package Dimensions**Notes:**

1. All dimensions are in millimeters (inches).
2. Tolerance is $\pm 0.2\text{mm}$ (.0079") unless otherwise noted.
3. Specifications are subject to change without notice
4. This drawing is only for indication, not as a basis for the actual structure.



Selection Guide

Part No	Lens Type	Source Color
FSL-2812080W-A2SN1628THH	Yellow	InGaN White

Electrical / Optical Characteristics At Ta=25 °C

Parameter	Symbol	Min.	Typ.	Max.	Unit	Test Condition
Iv	Luminous Intensity	1600	2400	2800	mcd	IF=20mA
2θ1/2	Viewing Angle		110		deg	
x	Chromaticity Coordinates		0.310		nm	IF=20mA
y			0.310		nm	IF=20mA
VF	Forward Voltage	2.9		3.7	V	IF=20mA
IR	Reverse Current			10	μ A	VR=5V

Note:

1. θ1/2 is the angle from optical centerline where the luminous intensity is 1/2 optical centerline value
2. The chromaticity coordinates(x,y) is derived form 1931 CIE chromaticity diagram.

Absolute Maximum Ratings At Ta=25°C

Parameter	White	Unit
Power Dissipation	110	mW
Peak Forward Current (1/10 Duty Cycle @ 0.1ms)	100	mA
Continuous Forward Current	25	mA
Reverse Voltage	5	V
Electrostatic Discharge Threshold(HBM)	2000	V
Operating Temperature Range	-30°C to + 85°C	
Storage Temperature Range	-40°C to + 100°C	
Soldering Condition	260°C For 10 Seconds	

Electrical Optical Characteristics Curves At Ta=25 °C

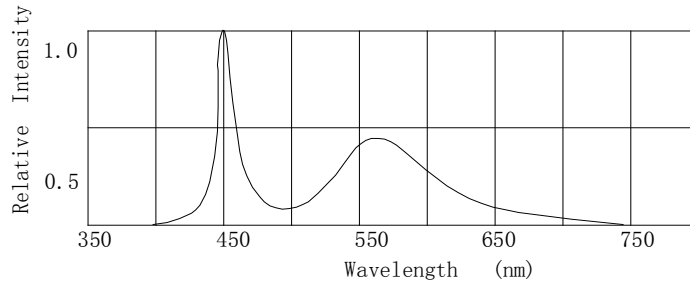

Fig.1 Relative Intensity VS. Wavelength

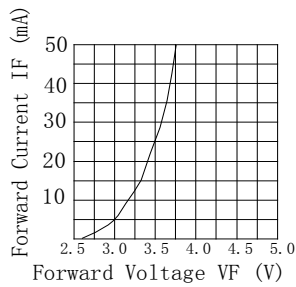

Fig.2 Forward Current vs. Forward Voltage

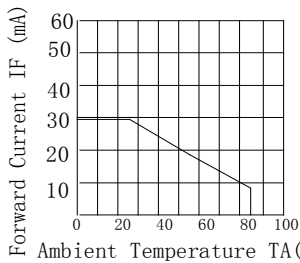

Fig.3 Forward Current Derating Curve

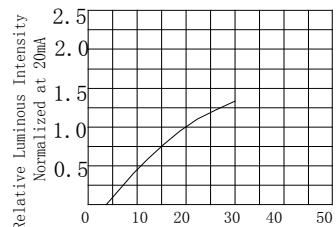

Fig.4 Relative Luminous Intensity vs. Forward Current

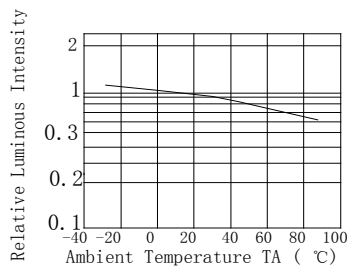

Fig.5 Luminous Intensity vs. Ambient Temperature

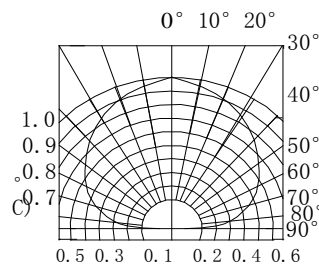

Fig.6 Spatial Distribution

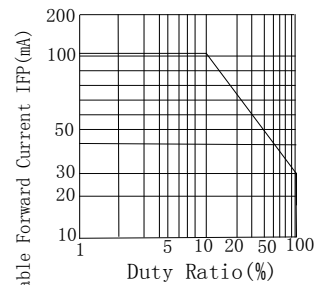

Fig.7 Duty Ratio vs. Allowable Forward Current

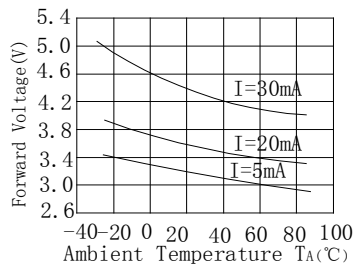

Fig.8 Ambient Temperature vs. Forward Voltage

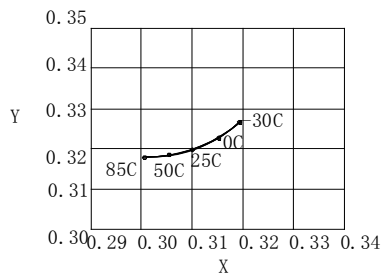

Fig.9 Ambient Temperature TA (°C) Chromaticity Coordinate

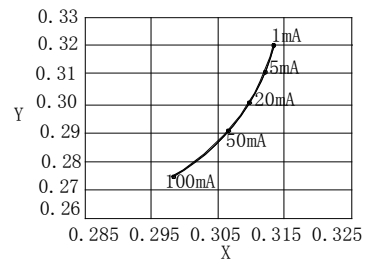

Fig.10 Forward Current VS. Chromaticity Coordinate



Bin Range Of Luminous Intensity (+/-20%)

Symbol	Bin Code	Min.	Max.	Unit	Condition
Iv	L16	1600	1700	mcd	IF=20mA
	L17	1700	1800		
	L18	1800	1900		
	L19	1900	2000		
	L20	2000	2100		
	L21	2100	2200		
	L22	2200	2300		
	L23	2300	2400		
	L24	2400	2500		
	L25	2500	2600		
	L26	2600	2700		
L27	2700	2800			

Bin Range Of Forward Voltage (+/-0.15)

Symbol	Bin Code	Min.	Max.	Unit	Condition
VF	V0	2.9	3.0	V	IF=20mA
	V1	3.0	3.1		
	V2	3.1	3.2		
	V3	3.2	3.3		
	V4	3.3	3.4		
	V5	3.4	3.5		
	V6	3.5	3.6		
	V7	3.6	3.7		

Chromaticity Coordinates Specifications for Bin Grading (+/-0.02) IF=20mA

Bin	CIE_x	CIE_y	Bin	CIE_x	CIE_y	Bin	CIE_x	CIE_y	Bin	CIE_x	CIE_y
B1	0.275	0.259	B2	0.264	0.243	B3	0.28	0.248	B4	0.275	0.259
	0.264	0.243		0.27	0.27		0.275	0.259		0.27	0.27
	0.272	0.2335		0.275	0.259		0.283	0.273		0.278	0.284
	0.28	0.248					0.288	0.262		0.283	0.273
W1	0.288	0.262	W2	0.286	0.298	W3	0.296	0.276	W4	0.291	0.287
	0.283	0.273		0.278	0.284		0.291	0.287		0.286	0.298
	0.291	0.287		0.283	0.273		0.299	0.301		0.294	0.312
	0.296	0.276		0.291	0.287		0.304	0.29		0.299	0.301
Y1	0.304	0.29	Y2	0.299	0.301	Y3	0.312	0.304	Y4	0.31	0.34
	0.299	0.301		0.294	0.312		0.307	0.315		0.302	0.326
	0.307	0.315		0.302	0.326		0.315	0.329		0.307	0.315
	0.312	0.304		0.307	0.315		0.32	0.318		0.315	0.329

CIE Chromaticity Diagram (+/-0.02) IF=20mA

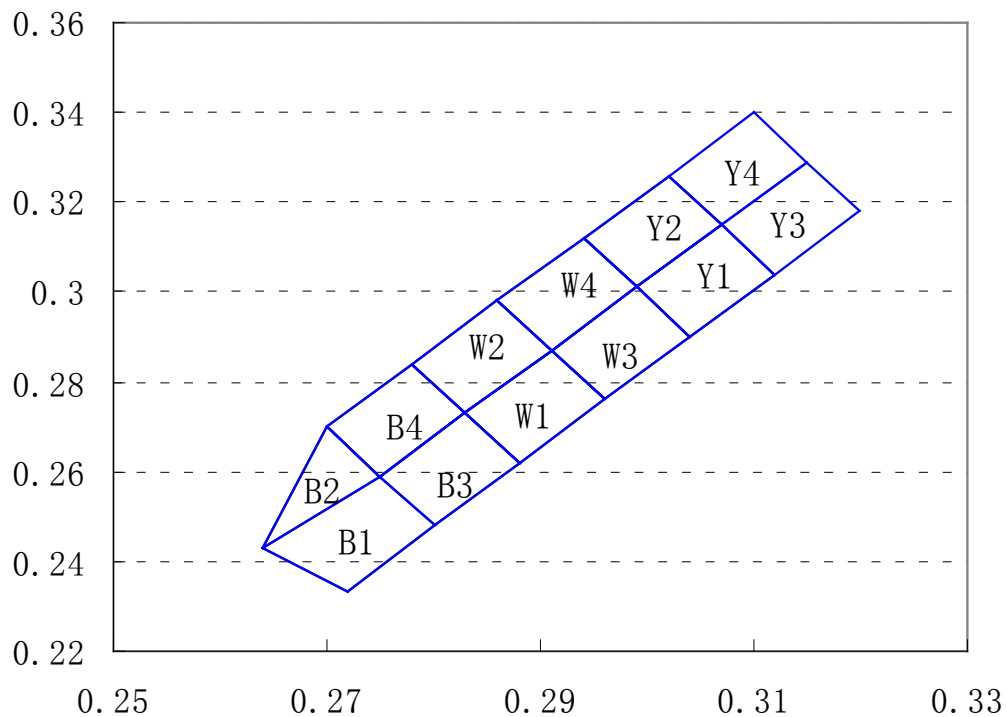

SMT Reflow Soldering Instructions

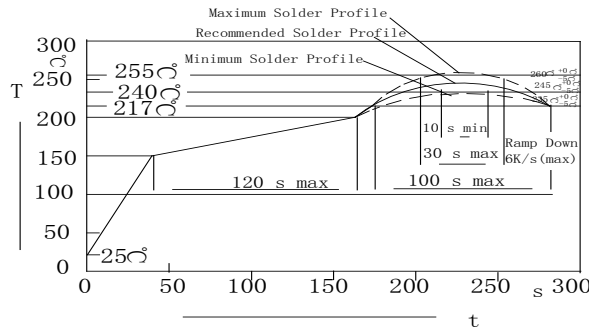

Notes:

- Selles gives no other assurances regarding the ability of to withstand ESD. It is recommended to use a wrist band or anti-electrostatic glove when handling the LED. All devices, equipment and machinery must be properly grounded.
- Reflow soldering should not be done more than two times.
- Do not stress LED when soldering, and do not warp the circuit board after soldering
- While using Iron, Power dissipation of Iron should be smaller than 25W, and temperature should be controllable. The work should be finished within 2 sec under 320°C for once only.

Recommended Soldering Pad Dimensions

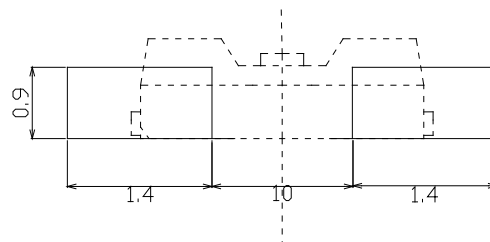

Package Specifications (Units: mm(inches))

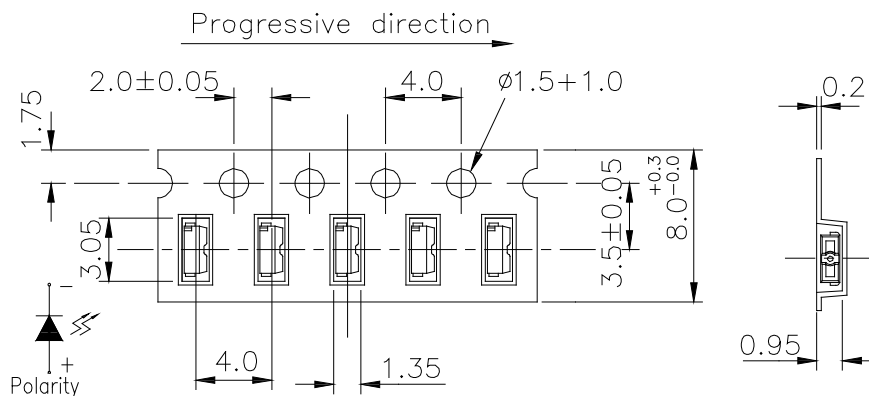

Notes:

- The LEDs should be used within a year.
- The LEDs should be kept in 5~30°C and 60% RH for less.
- The LEDs should be used within 24 hours, or else should be kept a 5~30°C and 30% RH or less. And LEDs should be used within 7 days after opening the package.

Reliability Test Items Conditions

Classification	Test Item	Test Conditions	Test hours	Result
Endurance Test	Operation Life	Connect with a power $I_F=20\text{mA}$ $T_a=\text{Under room temperature}$	1000Hrs	0/20
	High Temperature High Humidity	$T_a=+65^\circ\text{C}\pm 5^\circ\text{C}$ RH=90%-95%	240Hrs	0/20
	High Temperature Storage	High $T_a=+85^\circ\text{C}\pm 5^\circ\text{C}$	1000Hrs	0/20
	Low Temperature Storage	Low $T_a=-35^\circ\text{C}\pm 5^\circ\text{C}$ Test time=1000hrs	1000Hrs	0/20
Environmental Test	Temperature Cycling	$-45^\circ\text{C}\sim+105^\circ\text{C}$ 15min 5min 15min	300 Cycles	0/20
	Thermal Shock	$-35^\circ\text{C}\sim\pm 5^\circ\text{C}\sim+85^\circ\text{C}\sim\pm 5^\circ\text{C}$ 5min 10sec 5min	300 Cycles	0/20
	Solder Resistance	Preheating: $120^\circ\text{C}\sim 150^\circ\text{C}$, within 2 minutes. Operation heating : 260°C (Max.), within 5 seconds (Max.)	5Cycles	0/20

Judgment criteria of failure for the reliability

Measuring items	Symbol	Measuring conditions	Judgment criteria for failure
Forward voltage	$V_F(V)$	$I_F=20\text{mA}$	Over $U\times 1.2$
Reverse current	$I_R(\mu\text{A})$	$V_R=5\text{V}$	Over $U\times 2$
Luminous intensity	$I_v(\text{mcd})$	$I_F=20\text{mA}$	Below $S\times 0.5$

Note: 1.U means the upper limit of specified characteristics. S means initial value.

2.Measurment shall be taken between 2 hours after the test pieces have been returned to normal ambient conditions after completion of each test.