

Features

- 3.2mm*2.7mm SMT LED, Super thin (1.10H mm)
- Low Power Consumption
- Wide Viewing Angle
- Various Colors
- Compatible with automatic placement equipment.
- Compatible with infrared and vapor phase reflow and wave solder process.
- Meet ROHS Green Product.
- Package: 3000pcs/Reel

Applications

- Backlight and Indicator

Package Dimensions

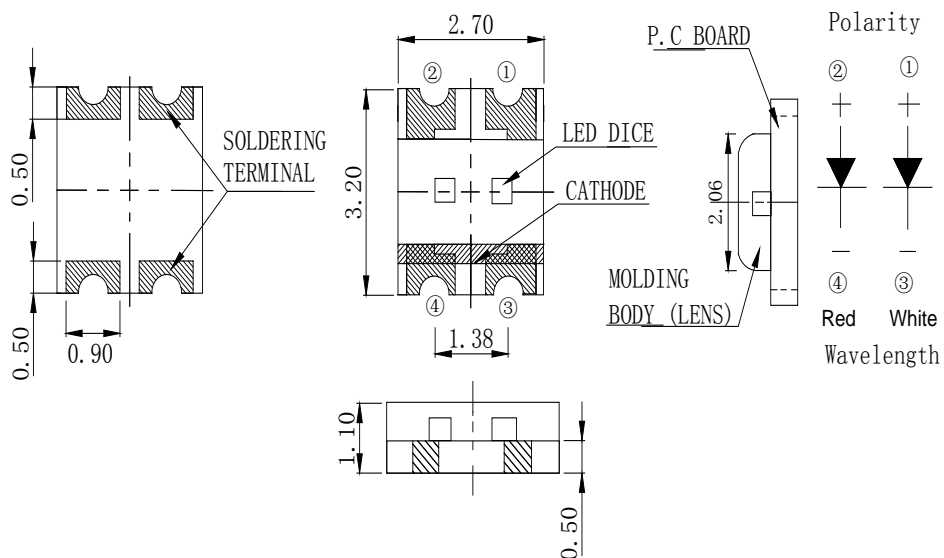

Notes:

1. All dimensions are in millimeters (inches).
2. Tolerance is $\pm 0.2\text{mm}$ (.0079") unless otherwise noted.
3. Specifications are subject to change without notice
4. This drawing is only for reference, not as a basis for the actual structure.



Selection Guide

Part No	Lens Type	Dice	Emitted Color
FSL-3227110WA-A4T5NYTLD	Yellow	InGaN AlInGaP	White Amber

Electrical / Optical Characteristics At Ta=25 °C

Symbol	Parameter		Amber	White	Unit	Test Condition
Iv	Luminous Intensity	MIN.	12	45	mcd	IF=5mA
		MAX.	71	180		
2θ1/2	Viewing Angle	TYP.	130	130	deg	IF=5mA
λ Peak(x)	Peak Emission Wavelength	TYP.	611	0.28	nm	IF=5mA
λ d(y)	Dominant Wavelength	TYP.	605	0.26	nm	IF=5mA
Δλ	Spectral Line Half-Width	TYP.	17	20	nm	IF=5mA
VF	Forward Voltage	MIN.	1.7	2.7	V	IF=5mA
		TYP.	2.3	3.1		

Note:

1. θ1/2 is the angle from optical centerline where the luminous intensity is 1/2 optical centerline value
2. The chromaticity coordinates(x,y) is derived form 1931 CIE chromaticity diagram.
3. The chromaticity coordinates(x,y) guarantee should be added±0.02 tolerance.

Absolute Maximum Ratings At Ta=25°C

Parameter	Amber	White	Unit
Power Dissipation	75	95	mW
Peak Forward Current[1]	80	100	mA
Continuous Forward Current	25	25	mA
Derating Linear From 25 °C	0.4	0.25	mA/°C
Reverse Voltage	5	5	V
Electrostatic Discharge Threshold(HBM)	2000	300	V
Operating Temperature Range	-55 °C to + 85 °C		
Storage Temperature Range	-55 °C to + 85 °C		
Soldering Condition	260 °C For 5 Seconds		

Note:

1. 1/10DutyCycle, 0.1msPulseWidth

Electrical Optical Characteristics Curves At Ta=25 °C

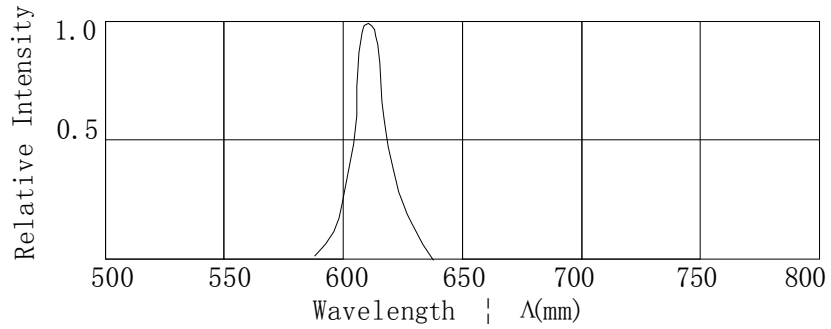

Relative Intensity vs. Wavelength

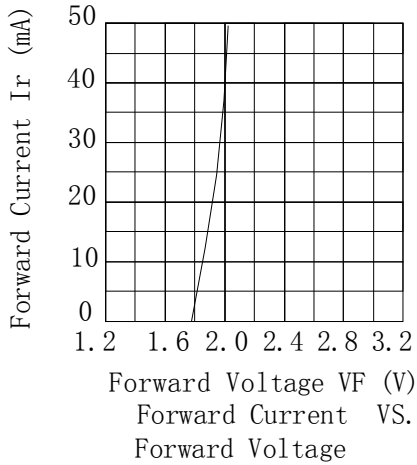

Forward Current VS. Forward Voltage

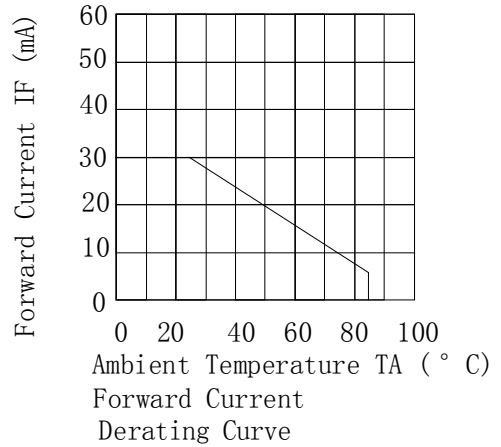

Forward Current Derating Curve

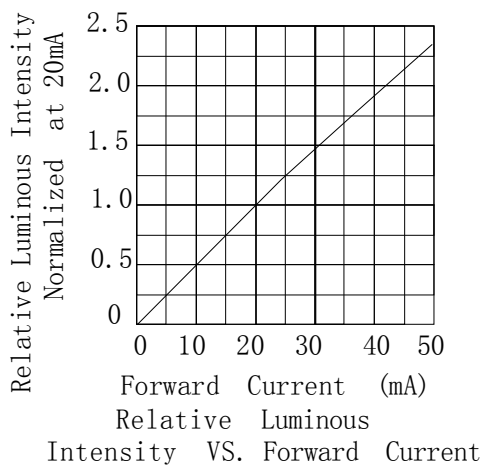

Relative Luminous Intensity VS. Forward Current

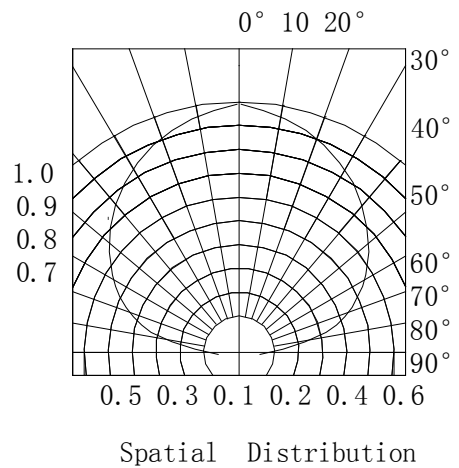

Spatial Distribution

Electrical Optical Characteristics Curves At Ta=25 °C

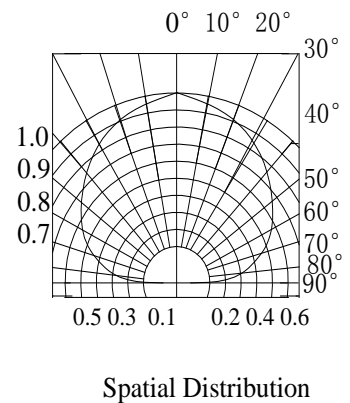
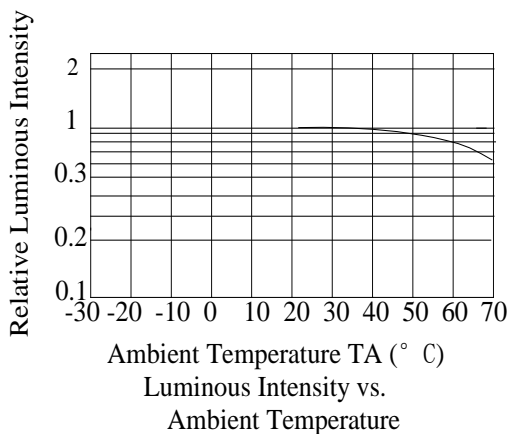
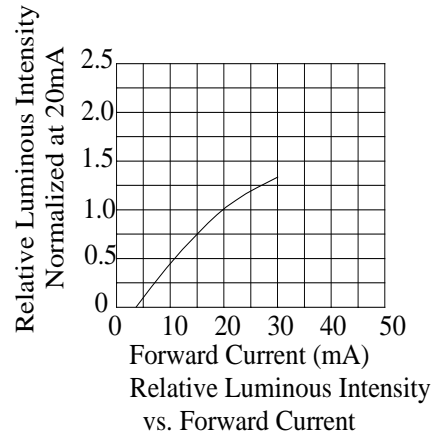
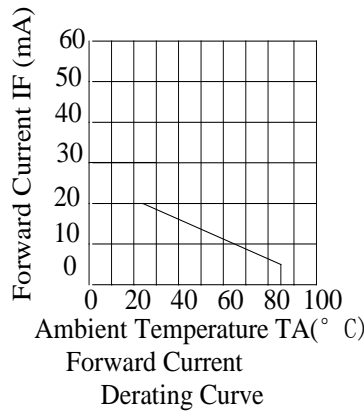
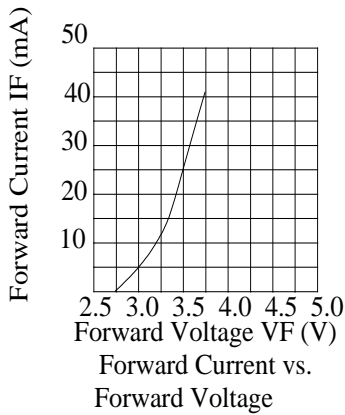
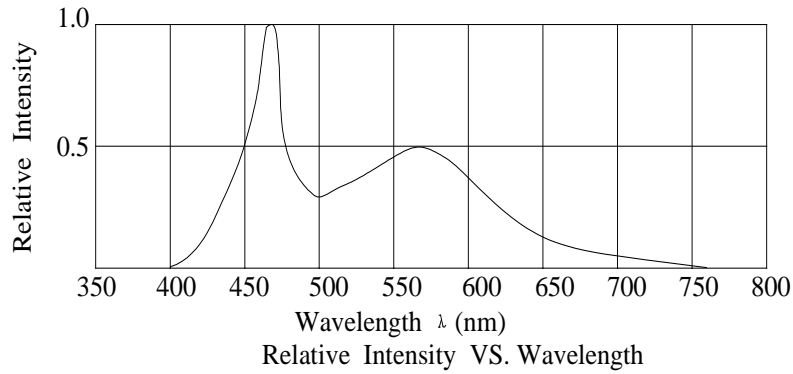



Bin Range Of Luminous Intensity(+/-20%)

Symbol	Bin Code	Min.	Max.	Unit	Condition
Iv(A)	L	11.2	18	mcd	IF=5mA
	M	18	28		
	N	28	45		
	P	45	71		
Iv(W)	P	45	72	mcd	IF=5mA
	Q	72	112		
	R	112	180		

Bin Range Of Dominate Wavelength(+/- 2nm)

Symbol	Bin Code	Min.	Max.	Unit	Condition
λ d(A)	A	598	605	nm	IF=5mA
	B	605	612		

Chromaticity Coordinates Specifications for Bin Grading (+/-0.02)

IF=5mA

BIN	X	Y	X	Y	X	Y	X	Y
B1	0.254	0.198	0.254	0.23	0.274	0.258	0.254	0.198
B2	0.254	0.23	0.254	0.263	0.274	0.291	0.274	0.258
B3	0.234	0.17	0.234	0.202	0.254	0.23	0.254	0.198
B4	0.234	0.202	0.234	0.235	0.254	0.263	0.254	0.23
S1	0.274	0.226	0.274	0.258	0.294	0.286	0.294	0.254
S2	0.274	0.258	0.274	0.291	0.294	0.319	0.294	0.286
S3	0.294	0.254	0.294	0.286	0.314	0.315	0.314	0.282
S4	0.294	0.286	0.294	0.319	0.314	0.347	0.314	0.315
S5	0.314	0.282	0.314	0.315	0.334	0.343	0.334	0.311
S6	0.314	0.315	0.314	0.347	0.334	0.376	0.334	0.343

CIE Chromaticity Diagram(+/-0.02)

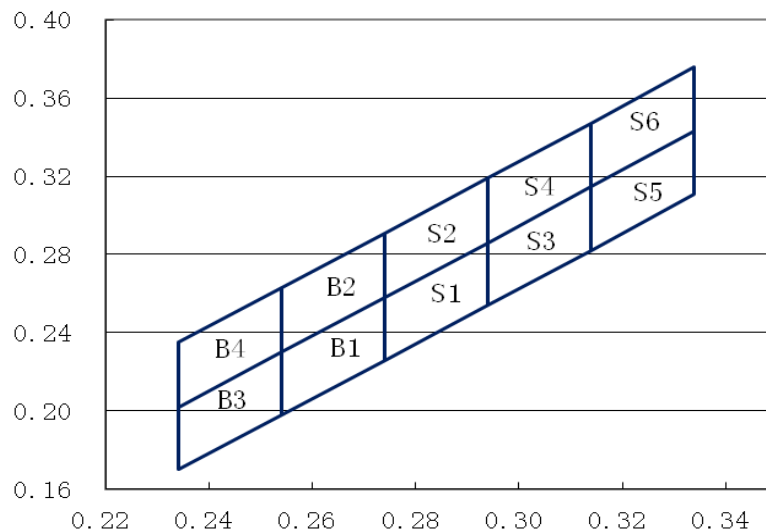

SMT Reflow Soldering Instructions

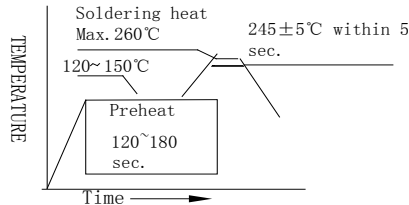

Notes:

1. Sells gives no other assurances regarding the ability of to withstand ESD. It is recommended to use a wrist band or anti-electrostatic glove when handling the LED. All devices, equipment and machinery must be properly grounded.
2. Reflow soldering should not be done more than two times.
3. Do not stress LED when soldering, and do not warp the circuit board after soldering
4. While using Iron, Power dissipation of Iron should be smaller than 25W, and temperature should be controllable. The work should be finished within 2 sec under 320°C for once only.

Recommended Soldering Pad Dimensions

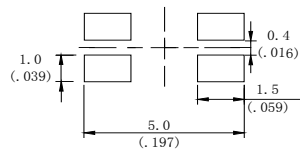

Package Specifications (Units: mm (inches))

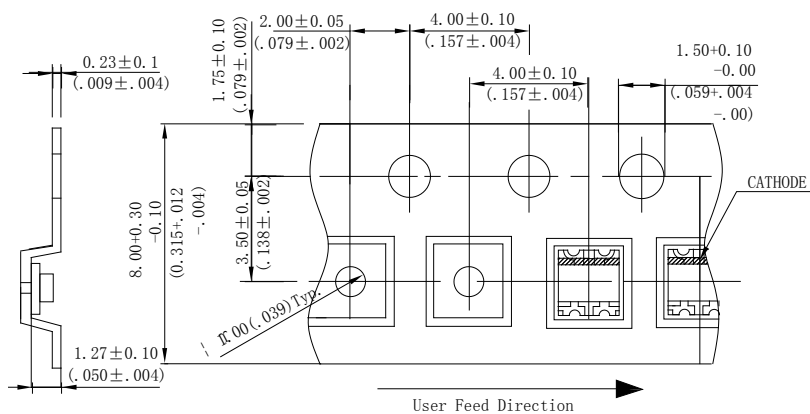

Notes:

1. The LEDs should be used within a year.
2. The LEDs should be kept in 5~30°C and 60% RH for less.
3. The LEDs should be used within 24 hours, or else should be kept in 5~30°C and 30% RH or less. And LEDs should be used within 7 days after opening the package.

Reliability Test Items Conditions

Classification	Test Item	Test Conditions	Test hours	Result
Endurance Test	Operation Life	Connect with a power $I_F=5mA$ T_a =Under room temperature	1000Hrs	0/20
	High Temperature High Humidity	$T_a=+65^{\circ}C\pm5^{\circ}C$ RH=90%-95%	240Hrs	0/20
	High Temperature Storage	High $T_a=+85^{\circ}C\pm5^{\circ}C$	1000Hrs	0/20
	Low Temperature Storage	Low $T_a=-35^{\circ}C\pm5^{\circ}C$ Test time=1000hrs	1000Hrs	0/20
Environmental Test	Temperature Cycling	$-45^{\circ}C\sim+105^{\circ}C$ 15min 5min 15min	300 Cycles	0/20
	Thermal Shock	$-35^{\circ}C\sim\pm5^{\circ}C\sim+85^{\circ}C\sim\pm5^{\circ}C$ 5min 10sec 5min	300 Cycles	0/20
	Solder Resistance	Preheating: $120^{\circ}C-150^{\circ}C$, within 2 minutes. Operation heating : $260^{\circ}C$ (Max.), within 5 seconds (Max.)	5Cycles	0/20

Judgment criteria of failure for the reliability

Measuring items	Symbol	Measuring conditions	Judgment criteria for failure
Forward voltage	$V_F(V)$	$I_F=5mA$	Over $U\times 1.2$
Reverse current	$I_R(\mu A)$	$V_R=5V$	Over $U\times 2$
Luminous intensity	$I_v(mcd)$	$I_F=5mA$	Below $S\times 0.5$

Note: 1.U means the upper limit of specified characteristics. S means initial value.

2.Measurment shall be taken between 2 hours after the test pieces have been returned to normal ambient conditions after completion of each test.