

**Features**

- 1.6mm\*0.8mm SMT LED, Super thin (0.40H mm)
- Low Power Consumption
- Wide Viewing Angle
- Various Colors
- Compatible with automatic placement equipment.
- Compatible with infrared and vapor phase reflow and wave solder process.
- Meet ROHS Green Product
- Package: 3000pcs/Reel

**Applications**

- Backlight and Indicator

**Package Dimensions**

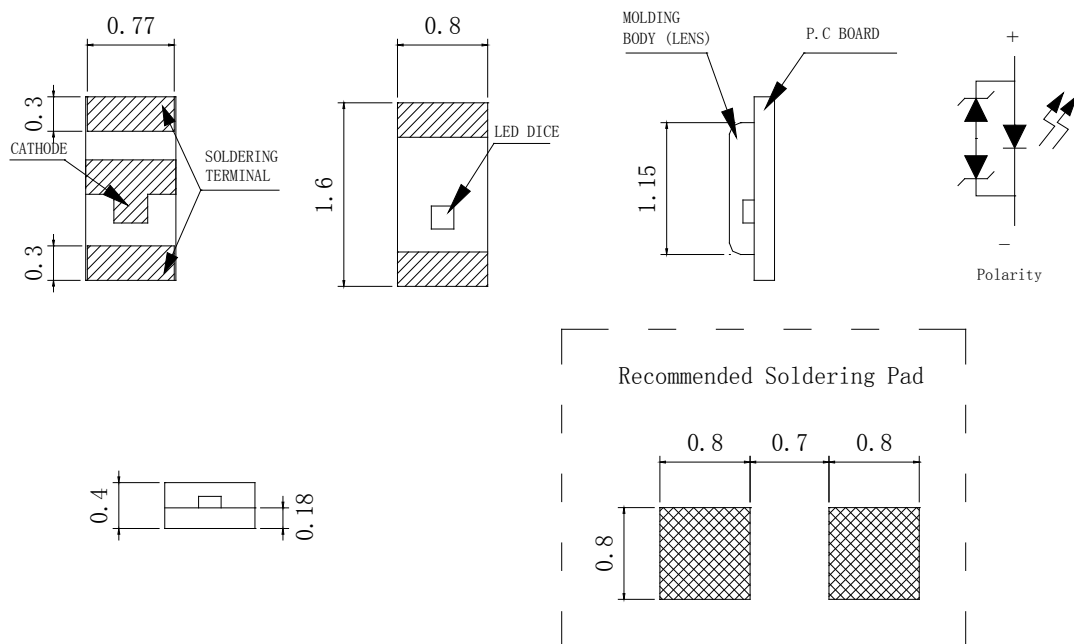

**Notes:**

1. All dimensions are in millimeters (inches).
2. Tolerance is  $\pm 0.2\text{mm} (.0079\text{'})$  unless otherwise noted.
3. Specifications are subject to change without notice
4. This drawing is only for reference, not as a basis for the actual structure.

**Selection Guide**

Part No	Lens Type	Dice	Emitted Color
FSL-C1608040TB-FATNHC3	Water clear	InGaN	Blue

**Electrical / Optical Characteristics At Ta=25 °C**

Parameter	Symbol	MIN.	TYP.	MAX.	Unit	Test Condition
Iv	Luminous Intensity	112	180	-	mcd	IF=20mA
2θ1/2	Viewing Angle	-	130	-	deg	IF=20mA
λ Peak	Peak Emission Wavelength	-	468	-	nm	IF=20mA
λ d	Dominant Wavelength	460	470	475	nm	IF=20mA
Δλ	Spectral Line Half-Width	-	25	-	nm	IF=20mA
VF	Forward Voltage	2.5	3.0	3.7	V	IF=20mA
VFz	Reverse Voltage	5.0	-	7.0	V	IFz=20mA

## Note:

1. θ1/2 is the angle from optical centerline where the luminous intensity is 1/2 optical centerline value
2. Tolerance of Luminous Intensity +/-10%
3. Tolerance of Forward Voltage +/-0.1V
4. Tolerance of the Dominate Wavelength +/- 1nm

**Absolute Maximum Ratings At Ta=25°C**

Parameter	Symbol	Blue	Unit
P <sub>D</sub>	Power Dissipation	110	mW
I <sub>FP</sub>	Peak Forward Current[1]	100	mA
I <sub>F</sub>	Continuous Forward Current	50	mA
D <sub>L</sub>	Derating Linear From 25°C	0.25	mA/°C
V <sub>R</sub>	Reverse Voltage	12	V
ESD <sub>HBM</sub>	Electrostatic Discharge Threshold(HBM)	2000	V
ESD <sub>MM</sub>	Electrostatic Discharge Threshold(MM)	200	V
T <sub>j</sub>	Junction Temperature	115	°C
R <sub>th J-A</sub>	Thermal resistance (J-A)	800	K/W
R <sub>th J-S</sub>	Thermal resistance (J-S)	450	K/W
T <sub>opr</sub>	Operating Temperature Range	-45°C to + 100°C	
T <sub>stg</sub>	Storage Temperature Range	-55°C to + 110°C	
T <sub>sol Ref</sub>	Soldering Condition(Reflow)	260°C For 30 Seconds	
T <sub>sol Hand</sub>	Soldering Condition (Hand)	350°C For 3 Seconds	

Note:

1. 1/10DutyCycle,0.1msPulseWidth

**Electrical Optical Characteristics Curves At Ta=25 °C**

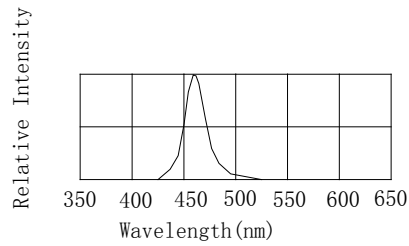

Relative Intensity vs. Wavelength

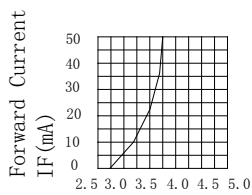

Forward Current vs. Forward Voltage

Forward Current vs. Forward Voltage

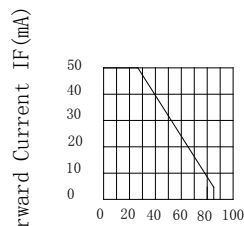

Forward Current Derating Curve

Forward Current Derating Curve

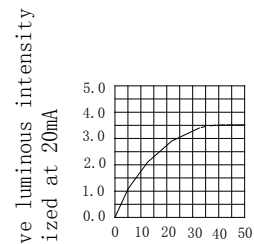

Forward luminous Intensity vs. Forward Current

Forward luminous Intensity vs. Forward Current

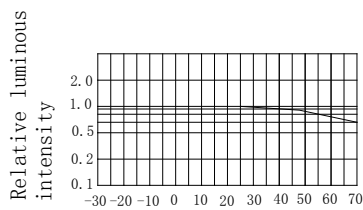

Relative Luminous Intensity vs. Ambient temperature

Relative Luminous Intensity vs. Ambient temperature

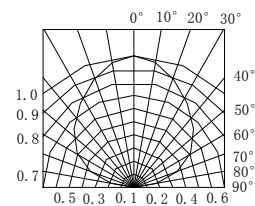

Spatial Distribution

Spatial Distribution

**Bin Range Of Luminous Intensity**

Symbol	Bin Code	Min.	Max.	Unit	Condition
Iv	R	112	180	mcd	IF=20mA
	S	180	280		
	T	280	450		

**Bin Range Of Forward Voltage**

Symbol	Bin Code	Min.	Max.	Unit	Condition
VF	V25	2.50	2.70	V	IF=20mA
	V27	2.70	2.90		
	V29	2.90	3.10		
	V31	3.10	3.30		
	V33	3.3	3.5		
	V35	3.5	3.7		

**Bin Range Of Dominate Wavelength**

Symbol	Bin Code	Min.	Max.	Unit	Condition
$\lambda d$	B1	460	465	nm	IF=20mA
	B2	465	470		
	B3	470	475		

Notes:

1. Tolerance of Luminous Intensity +/-10%
2. Tolerance of Forward Voltage +/-0.1V
3. Tolerance of the Dominate Wavelength +/- 1nm

### SMT Reflow Soldering Instructions

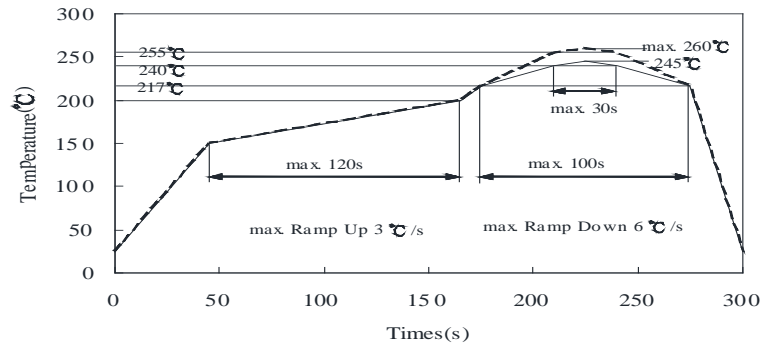

**Notes:**

1. Selles gives no other assurances regarding the ability of to withstand ESD. It is recommended to use a wrist band or anti-electrostatic glove when handling the LED. All devices, equipment and machinery must be properly grounded.
2. Reflow soldering should not be done more than two times.
3. Do not stress LED when soldering, and do not warp the circuit board after soldering
4. While using Iron, Power dissipation of Iron should be smaller than 25W, and temperature should be controllable. The work should be finished within 2 sec under 320°C for once only.

### Application

In order to ensure intensity uniformity on multiple LEDs connected in parallel in an application, it is recommended to use individual resistor separately, as shown in Circuit A below. The brightness of each LED shown in Circuit B might appear difference due to the differences in the I-V characteristics of those LEDs.

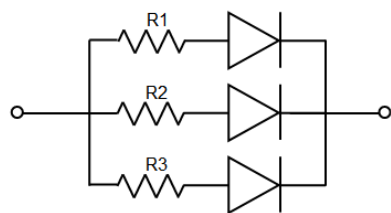

**Circuit model A**

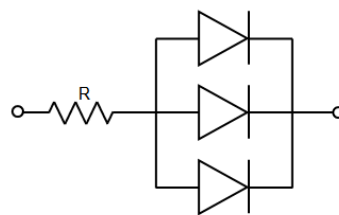

**Circuit model B**

**Reel Dimensions**

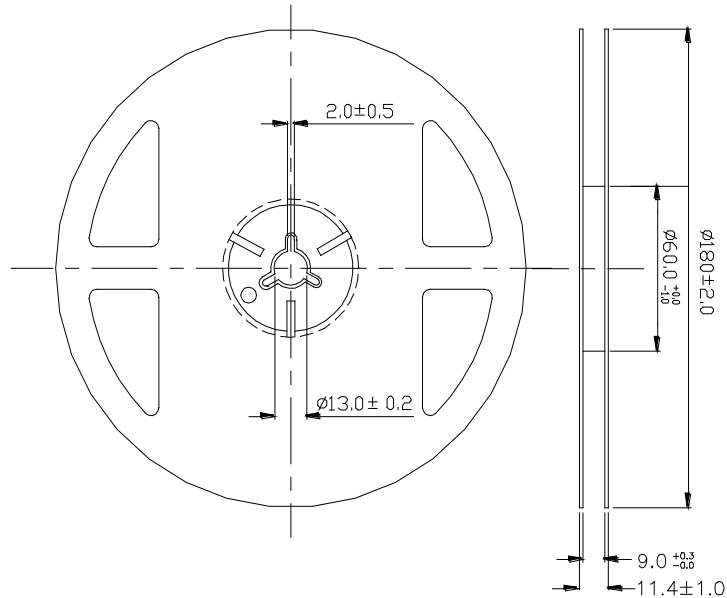

**Package Specifications (Units: mm(inches))**

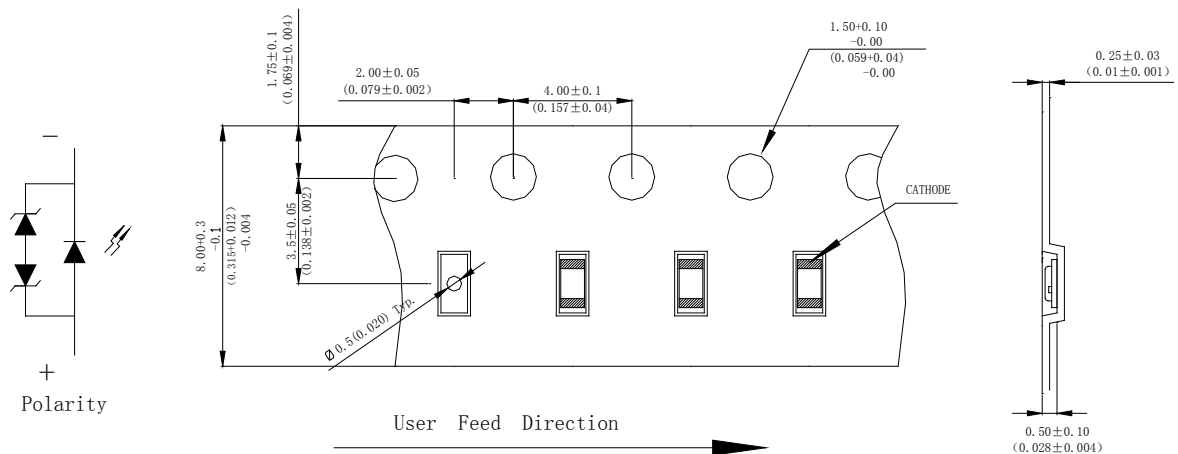

**Notes:**

1. The LEDs should be used within a year.
2. The LEDs should be kept in 5~30°C and 60% RH for less.
3. The LEDs should be used within 24 hours, or else should be kept a 5~30°C and 30% RH or less. And LEDs should be used within 7 days after opening the package.

**Reliability Test Items Conditions**

Classification	Test Item	Test Conditions	Test hours	Result
Endurance Test	Operation Life	Connect with a power $I_F=20\text{mA}$ $T_a$ =Under room temperature	1000Hrs	0/20
	High Temperature High Humidity	$T_a=+65^\circ\text{C}\pm 5^\circ\text{C}$ RH=90%-95%	240Hrs	0/20
	High Temperature Storage	High $T_a=+100^\circ\text{C}\pm 5^\circ\text{C}$	1000Hrs	0/20
	Low Temperature Storage	Low $T_a=-50^\circ\text{C}\pm 5^\circ\text{C}$ Test time=1000hrs	1000Hrs	0/20
Environmental Test	Temperature Cycling	$-50^\circ\text{C}\sim +105^\circ\text{C}$ 15min 5min 15min	300 Cycles	0/20
	Thermal Shock	$-45^\circ\text{C}\sim +5^\circ\text{C}\sim +85^\circ\text{C}\sim +5^\circ\text{C}$ 5min 10sec 5min	300 Cycles	0/20
	Solder Resistance	Preheating: $120^\circ\text{C}-150^\circ\text{C}$ , within 2 minutes. Operation heating : $260^\circ\text{C}$ (Max.), within 10 seconds(Max.)	5Cycles	0/20

**Judgment criteria of failure for the reliability**

Measuring items	Symbol	Measuring conditions	Judgment criteria for failure
Forward voltage	$V_F(V)$	$I_F=20\text{mA}$	Over $U\times 1.2$
Reverse current	$I_R(\mu\text{A})$	$V_R=5\text{V}$	Over $U\times 2$
Luminous intensity	$I_v(\text{mcd})$	$I_F=20\text{mA}$	Below $S\times 0.5$

Note: 1.U means the upper limit of specified characteristics. S means initial value.

2.Measurment shall be taken between 2 hours after the test pieces have been returned to normal ambient conditions after completion of each test.



**Moisture Resistant Packaging**

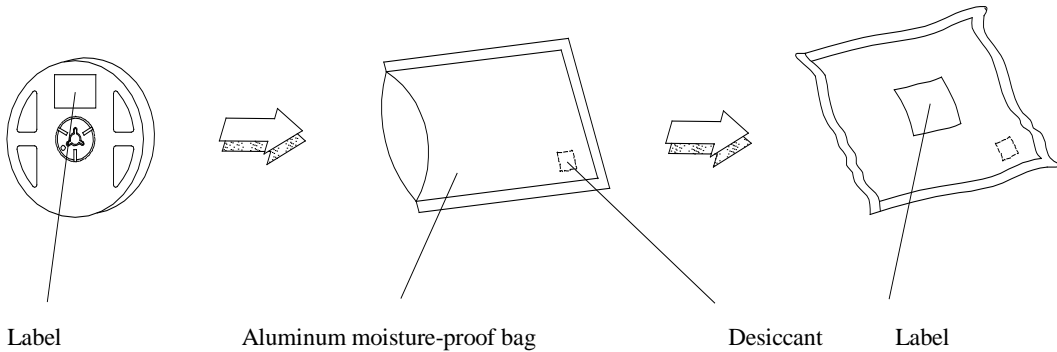

Remark: Add Desiccant into Aluminum moisture-proof bag

**Label Explanation**

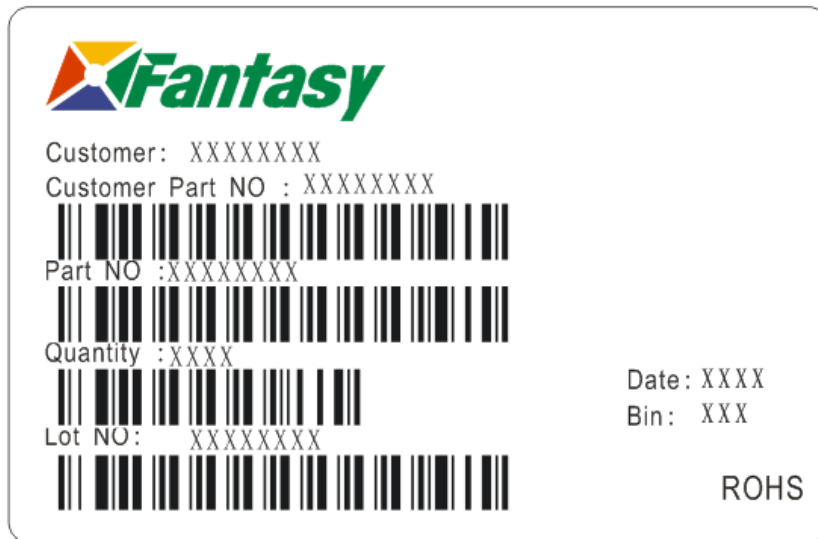

- Customer: Customer Name
- Customer Part NO: Customer's Product Number
- Part NO : Fantasy Product Number
- Quantity : Packing Quantity
- Lot NO : Lot Number
- Date : Product Date (Week)
- Bin: Rank of Luminous Intensity ,Dom. Wavelength, Forward Voltage